

A dark blue silhouette of a world map is centered in the upper half of the page, set against a lighter blue background with faint circular grid lines.

HYBRID MINI-GRIDS FOR RURAL ELECTRIFICATION: LESSONS LEARNED



USAID
FROM THE AMERICAN PEOPLE



Alliance for
Rural
Electrification

HYBRID MINI-GRIDS FOR RURAL ELECTRIFICATION: LESSONS LEARNED

Disclaimer

The views expressed in this publication do not necessarily reflect the views of the United States Agency for International Development or the United States Government.

Prepared by:  Alliance for Rural Electrification (ARE)

Rue d'Arlon 69-71
1040 Brussels
Belgium
Tel: +32 2 709 55 42
www.ruralelec.org

TABLE OF CONTENTS

Acknowledgments	5
Executive summary	5
1. Introduction	9
2. Hybrid mini-grid power systems: a technology primer	12
2.1. Why a hybrid mini-grid?	12
2.2. Differences between hybrid power systems, diesel genset power systems, and renewable energy power systems	12
2.3. Design of hybrid mini-grids	13
3. Cost Structures	15
3.1. Technology cost comparison	15
3.2. Adjusting the model for varying natural conditions	17
3.3. Adjusting the model for varying diesel fuel prices	19
4. Business models for rural power mini-grids	21
4.1. Community-based model	21
4.2. Private sector-based model	24
4.3. The utility-based model	28
4.4. Hybrid business model	28
5. Business, economic, and social factors	31
5.1. Operation and maintenance issues	31
5.2. Local private sector development and access to local financing	32
5.3. Information, marketing, education and capacity building	34
5.4. Business enabling environment and regulations	37
5.4.1. Acting on the market itself: productive use and market aggregation	37
5.4.2. Acting on the project revenues: tariffs and subsidies	40
- Tariffs and subsidies	40
- Tariff collection mechanisms	45
5.4.3. Acting on regulation: policies and contractual agreements	47
Conclusion	51
Annex 1: Technologies, Design and Efficiency	52
1. Hybrid technologies and system design issues	52
1.1. Solar PV	52
1.2. Small wind	53
1.3. Micro-hydro	54

TABLE OF CONTENTS

1.4. Diesel genset	54
1.5. Batteries	55
1.6. Mini-grid configuration	56
1.6.1. Components coupling: AC vs. DC bus bar	56
1.6.2. Single vs. three-phase distribution line	56
1.6.3. Different configuration models	56
1.7. Sizing the project	58
1.8. Demand load dimension	58
1.9. Load management strategies	59
2. Energy efficiency	60
Annex 2: International standards for mini-grids	63
Annex 3: References and bibliography	66

Acknowledgements

This study would not have been possible without the great commitment and work of Simon Rolland, ARE Policy and Development Manager (lead on business models and on business, economic, and social factors) and Carlos Guerrero (lead on technologies and cost calculations).

The Alliance for Rural Electrification (ARE) is grateful for the contributions of the following experts: Xavier Vallvé (Trama Techno Ambiental, Spain), Andy Schroeter (Sunlabob, Laos), Mike Bergey and Charlie Dou (Bergey Wind Power), Lars Koerner (SolarWorld, Germany), Martin Bölli and Matthias Wiget (Entec AG, Switzerland), Balthasar Klimbie (Fortis Wind Energy, The Netherlands), David L. Seymour (Asian Phoenix Resources, Canada), Anjali Shanker (IED, France) and Fabian Jochem (Juwi Solar, Germany).

Executive Summary

Currently around 1.5 billion people worldwide live without access to electricity, and without a concerted effort, this number is not likely to drop. Grid extension is often highly costly and not feasible in isolated rural areas, or is unlikely to be accomplished within the medium term in many areas. In such situations, electricity mini-grids can power household use and local businesses. They provide centralized electricity generation at the local level using a village distribution network and, when fed with renewable or hybrid systems, increase access to electricity without undermining the fight against climate change.

Members of the Alliance for Rural Electrification (ARE) have been involved in the implementation of hundreds of mini-grid projects around the world. The lessons learned from these projects, which are summarized in this report, provide insights on the key issues that must be considered to devise sustainable, replicable models for the scale-up of hybrid mini-grids. Implementing sustainable hybrid mini-grids involves complex technical, financial and organizational issues which must address the end-users and their needs, capacity building and training, tariff and subsidy setting, and institutional strength.

I. Technical Issues

The combination of generation sources and components selected for a hybrid system will have a real influence on the life time of the system and its affordability to end-users. Despite the fact that the economic situation of rural areas pushes for technology choices made on a short term least-cost basis, quality has a dramatic influence on the system's lifetime and no compromises should be made on the quality of system components to reach the real long term lowest generation costs.

To increase efficiency gains and cost savings, priority should be given to sizing the system appropriately and to energy efficiency. In fact, regardless of the choices, energy efficiency is very important since it can influence dramatically the energy load, and therefore the amount of power generation required. This will impact investment costs and the financial viability of the project. In fact, for most countries supply and demand side management should constitute the first energy policy. In many rural communities, there is a tendency to focus on the reduction of short-term investment costs, which will necessitate on-going awareness raising and efforts to bolster local availability of energy-efficient appliances.

The decision on the energy sources to use is of course central. Diesel is an expensive resource often difficult to distribute in rural areas. Consequently, 100% diesel-fuelled mini-grids likely will be more expensive on a lifetime basis than hybrid ones, and they are also less autonomous as fuel availability cannot be assured. Hybrid mini-grids, in contrast, utilize local renewable resources, making it less likely that power will not be available.

Several types of renewable energy technologies can be utilized in mini-grids:

- Small or micro-hydro is the cheapest technology, but also the most site dependent, as it requires a river with specific flow rate and volume conditions. Small hydro is a mature technology which has been installed all over the world over the past 30 years.
- Solar photovoltaic (PV) is suitable for almost any location around the world and is also comparatively easy to install, maintain and scale up. However, initial investment costs are higher than those of other technologies.
- Small wind power technology is very site specific, since wind conditions vary dramatically from place to place therefore, wind resources must be carefully studied before a system is installed. However, on

Batteries and diesel gensets are other important components of hybrid systems. The battery is a central element for the cost of electricity over the lifetime of the system. Appropriate energy management should maximize the lifetime of the batteries as replacement costs represent an important part of the overall project costs. The genset will play an important role in ensuring the battery is charged. The use of diesel generators should be minimized as fuel is costly; however, the genset is important to ensure quality of service when the other technologies are low or when the demand is especially high. There should be always some kind of automatic management measures built into the system to protect critical components from severe damage, such as total depletion of the battery charge. Training of local operators and users is essential to ensure that the components are used correctly and will last throughout the whole projected lifetime.

Bus bars and local distribution network are the last key elements within a hybrid mini-grid. The choice of AC or DC current in particular has an impact on the system, its capacities and its price, as well as on the devices that can be powered. However, the choice of AC or DC mostly depends on the technologies to be coupled in the system as well as whether batteries will be used in the system. Single-phase distribution grids are cheaper than three-phase ones, but the later allow greater opportunity for commercial enterprises to obtain power and the possibility of future inter-connection to the national grid.

Field studies and exhaustive demand analysis are a basic pre-requisite for any mini-grid project, regardless of the technology selected. Over-sizing some components, such as wiring and the converters, can be a good idea to anticipate a future demand growth and facilitate the mini-grid's expansion.

II. Financial/Sustainability Issues

Financial and operation issues are critical to the long-term sustainability of mini-grids. Questions such as operations and maintenance, role of the private sector, tariffs and subsidies, and capacity building and training are essential to consider when developing rural electrification programs. This is particularly true with the use of hybrid mini-grids. Key issues to consider follow.

1) Sustainable financial and technical solutions for operations, maintenance and management (O&M&M) are key to overall system success. A well maintained and managed system can run over 25 years and this should be the target of every new system implemented worldwide. Therefore O&M&M have to be carefully integrated in the project business planning right from the inception in order to foresee a cash flow sufficient to cover these costs. The ownership rights and the role of each partner also must be clarified, to determine who is going to be responsible for what and for which investment.

If long-term O&M&M is the key indicator of a successful project/program, many external factors will also play a role. Availability (of products, trainings, reliable actors willing to assume responsibility for O&M, spare parts) for instance is of the biggest importance as is access to finance at all project levels. Therefore, successful rural electrification programs have to rely on functioning networks of local companies and financial intermediaries, which should be looked at and supported in parallel with or as part of the program. This can be addressed in different ways: for example, through technology transfer and company agreements, well-designed call for tenders, technical and business trainings and support to business organizations. The financial sector especially is central and its absence is often critical in rural areas. Therefore, targeted capacity building actions as well as financial instruments such as guarantees and financial risk mitigation instruments are very important.

2) In general, access to information and to training is fundamental to ensure long-term program success. Many stakeholders involved in the rural electrification project chain do not know how to deal with renewable energies, or may not be used to obtaining and paying for electricity. Hence, education, trainings and information about the benefits of access to energy and of renewables are necessary prior to any project. Strong and targeted publicity campaigns explaining rural electrification programs will also increase positive impacts.

3) The private sector must in the future play a bigger role in investing, implementing and operating hybrid systems all over the world if investment is to be scaled up and the challenges to system sustainability are to be overcome. Several factors can be influenced to attract companies and investors over the long term:

- The first option to increase the economic attractiveness of rural electrification is to act on the size of the market. To become more interesting economically, projects should be built ideally around existing business applications or public institutions in order to increase their critical mass, potential profits, and local involvement (i.e., interest in maintaining a system).

- Another option is to support directly income generating activities as part of the rural electrification project itself to increase the positive impacts on the community and generate the needed revenues to cover O&M&M and profits.
- Concentrating energy loads or bundling projects in attractive packages is another means of increasing market size and the attractiveness of rural electrification projects. Territorial concessions are a known and good strategy but they need to be simplified to diminish the costs and the time involved in the process.

4) Setting appropriate tariffs and subsidies (i.e., obtaining the right energy price) is probably the most important factor to ensure project sustainability. A sustainable rural electrification tariff must at least cover the system's running and replacement costs (break-even tariff), even though the opportunity for profit is key to attract private operators (financially viable tariffs). Tariffs must also maintain the balance between commercial viability and consumers' ability and willingness to pay.

Along with good tariff structures, smart combinations of subsidies are key to attract operators and ensure project sustainability. They can support the investment, the connection, the operation, and/or the output. Investment subsidies are a good solution if they go along with a good tariff structure, whereas Output Based Aid (OBA) schemes, if adequately planned, are powerful instruments to leverage private investments and ensure O&M. Other forms of support should be offered in parallel to project developers: tax credits; low import duties; site surveys; market studies; and capacity-building.

Regulations, policies and the legal framework are another incentive or barrier to the development of economic activities. This is particularly true for rural electrification with mini-grids, which offer a long-term service requiring stability and suitable instruments. Regulation has to be an instrument favouring new projects, not a burden. It needs to be light and flexible for small power producers in terms of standards and tariffs, and at the same time, it has to protect rural consumers. Power purchase agreements (PPAs) are an especially important feature, since these contracts are regulating the relations between the different parties involved in a long-term rural electrification project with a mini-grid. PPAs frame these relations and must give enough confidence to the private and banking sectors to invest in a project. PPAs must be fair, binding, ban unilateral changes and protect every actor equally. PPAs should also be as standardized as possible to decrease administrative costs, increase efficiency, simplify procedures, and most of all to enhance market transparency and attract operators and lenders.

III. Organizational Issues

The development of sustainable mini-grid projects can follow several business models according to local social and economic conditions.

- The community-based model has been tried out extensively around the world with varying success, depending mostly on the involvement of the people and the pricing policy. The community has to be involved as soon and as much as possible through financial or in-kind participation and through the constitution of a social structure supervising the implementation and the O&M&M of the project. Even community-based organisations need structured legal rules and binding contracts should be signed to secure payments with clear penalties in case of contract breaches.
- Tariffs have to be determined in advance, but flat-fees with categories adapted to different users are usually a good option since consumption is generally low. Tariffs always have to be high enough to cover O&M as well as replacement costs. Some community-run mini-grids have proved to be successful and this type of organization can have many positive impacts on the community itself in terms of self governance and local buy-in into the electrification system. However, this approach also needs a long preparation period and much technical and social capacity building to compensate for the lack of skills and the potential for social conflicts. Therefore, the introduction of another partner – either private or public – to take over some aspects of system management is preferable.
- Another business approach for mini-grid rural electrification is based on a private operator, whose participation is only realistic if a project is profitable and therefore attractive. Output-based aid and long-term concession, when well designed, can be attractive schemes to increase private sector participation; and a certain level of standardization is advised to reach a certain degree of replication and economies of

scale. Strong and targeted marketing around the call for tenders and the program are key to attract private sector participation. However, operators should be the main designer of their system based on costs and quality, but including consumer health and the environment as criteria. Private providers present the advantages of having some investment capacity and should have technical capacity, so that they can handle all operational issues. However, to be developed extensively in rural areas this model requires significant training, both on technical and business issues. Also, this approach requires community involvement and a proactive private sector development component to build demand for electricity services.

- The utility-based model is another option which has been widely used around the world. Utilities generally have more experience, financial resources, and technical capabilities to carry out rural electrification projects. They can realize economies of scale and use their central position to take advantage of financing options, but many of them are also inefficient and lack commitment at the local level. If this model is to be successful, it has to follow a business-oriented approach. Because of their capacities and experience, utilities should have a role to play in the future; however, partnering with private sector and community-based organizations will allow them to avoid the barriers linked with their centralized management structure and size. This type of hybrid, public-private model is probably the most interesting structure, but is also the hardest to define because it can encompass many different approaches. Hybrid business models tend to be very site specific and thus can be quite diverse with changing ownership structures, O&M contracts, and other variables.

Continuing and adapted capacity building and training on technical, business, financing, and institutional aspects of project and program development is necessary at every point of the project chain and must include every stakeholder. Lack of financial, institutional, and technical capacity is still one of the main reasons for unattractive programs and misunderstandings between the public and the private sector, including the financial sector. General training on rural electrification should therefore be provided to all stakeholders. At the local level, detailed technical training for end-users (i.e., customers) must cover both electricity uses (energy efficiency, load management) and technical limitations of the mini-grid. The personnel responsible for O&M should also be trained right from project implementation, with follow-up training over the long term.

For the sake of project sustainability the involvement of all the local stakeholders of the project is fundamental: Local authorities should be involved from the inception regardless of the business model chosen for the project. They can help assess electricity needs, conduct good project monitoring, help organize the community, enforce the rules, help develop local productive enterprises or added-value activities, etc. The participation of the local community can take different forms: participation in the initial investment, connection fee, monthly payment etc. It is also fundamental that the disconnection policy be clear and enforced. Finally, the involvement of the local personnel responsible for the O&M can be increased by tying salaries with system performance.

1. Introduction

Reliable access to electricity is a basic precondition for improving people's lives in rural areas, for enhanced healthcare and education, and for growth within local economies. At present, more than 1.5 billion people worldwide do not have access to electricity in their homes. An estimated 80% of these people live in rural areas; most have scant prospects of gaining access to electricity in the near future. By 2030, according to International Energy Agency projections, the number of people without electricity is not likely to drop due to population growth (see Tables 1 and 2).

Table 1. Electricity Access in 2008: Regional Aggregates¹

	Population without electricity	Electrification rate	Urban electrification rate	Rural electrification rate
	million	%	%	%
Africa	589	40	66.8	22.7
- North Africa	2	98.9	99.6	98.2
- Sub-Saharan Africa	587	28.5	57.5	11.9
Developing Asia	809	77.2	93.5	67.2
- China and East Asia	195	90.2	96.2	85.5
- South Asia	614	60.2	88.4	48.4
Latin America	34	92.7	98.7	70.2
Middle East	21	89.1	98.5	70.6
Developing countries	1453	72	90	58.4
OECD and Transition economies	3	99.8	100.0	99.5
World	1456	78.2	93.4	63.2

Table 2. Access to Electricity in Selected Sub-Saharan African Countries²

	2006		2030	
	Population without access (million)	% of population	Population without access (million)	% of population
Angola	12.9	88	18	59
Cameroon	14.2	78	17	64
Chad	10.1	97	18	92
Congo	2.9	78	4	68
Cote d'Ivoire	11.6	61	14	50
Equatorial Guinea	0.4	73	0.4	50
Gabon	0.9	70	1.2	66
Mozambique	18.6	89	22	72
Nigeria	76.6	53	66	29
Sudan	26.9	71	30	51
Total	176.9	65	191	44

1 IEA, World Energy database 2010.

2 World Energy Outlook, 2008, IEA.

There are three basic technical approaches to bring electricity to remote areas:

A first option is simply to extend the national grid. In many countries, however, extending the national grid can be extremely costly (see table 3). Rural areas are normally located far from the national grid, therefore the high cost of extending the transmission lines usually make these projects unfeasible. The terrain also increases expansion costs significantly. Mountainous areas with difficult access for machinery require more time and resources to install transmission lines. A third factor, the size of the demand, determines the cost per kWh of expanding the grid. A critical mass is necessary for a project to be viable. Rural areas are generally small in size and their use of energy limited. In cases where there is no access at all to electricity, the potential demand must be calculated precisely. Although prices for grid extension differ from country to country, in many of them extension to an isolated village is viable only at a certain distance and as long as the village has a large enough demand to reach critical mass. Otherwise, off-grid electrification is the most cost-effective option. The connection to the national grid has some well-known advantages (including reliability, cheaper costs, economies of scales) in comparison with off-grid systems; however it is important to bear in mind certain issues:

- Grid electricity tariffs are the same for rural consumers connected to the grid as they are for urban users, whereas costs are dramatically different. Hence, costly grid extension projects increase the overall price of the electricity for both urban and rural consumers.
- The electricity provided by the utility companies in developing countries often lacks the security of supply and quality of developed countries. Consumers may have access to the electricity during limited hours each day and blackouts or brownouts are common. Grid extension increases the demand, but if there is not a consequent increase in the energy generation capacity, adding new consumers only aggravates the situation and reduces even more the quality of the service.
- Grid extension is often a political tool. On the one side, grid extension electrifies more users per monetary unit than off-grid rural electrification programs, and faster. As a result, policymakers have a tendency to prioritize the extension of the grid to peri-urban areas in order to maximize their political support, or to provide electricity to urban populations that are more politically active and organized than rural ones. In fact, unrealistic political promises of future connection to the national grid are harmful for both consumers and the industry. People will be encouraged to wait for the grid for many years rather than taking the initiative and supporting off-grid solutions; and companies may fear that their investment in off-grid solutions may prove worthless if the grid is indeed extended.

Table 3. Costs of Grid Extension in Selected Countries (US\$ per kilometer)³

Country	Labor & other costs	Materials	Total
Bangladesh	\$ 350	\$ 6,340	\$ 6,690
Laos	\$ 1,420	\$ 7,230	\$ 8,650
El Salvador	\$ 2,090	\$ 6,160	\$ 8,250
Kenya	\$ 6,590	\$ 5,960	\$12,550
Senegal	\$ 5,150	\$10,810	\$15,960
Mali	\$ 2,590	\$15,170	\$19,070

The second approach goes through the so called Energy Home System (EHS). The selection of this technology will depend mainly on the dispersion of the households and the types of load required. A village often can support the installation of its own small power system, but the distribution grid costs represent a big share of the project and its feasibility. In contrast with a scattered population, covering a large area will entail higher connection costs, due to longer distribution lines. In these cases, stand-alone systems can be a better solution. Solar home systems (SHS), pico-hydro systems (PHS), or wind home systems (WHS) are often the solution to provide energy access to isolated households. In these stand-alone systems, the power generation is installed close to the load and there are no transmission and distribution costs. However, the total cost of energy tends to be higher due to the lack of economies of scale. To keep prices affordable, components are minimized and capacities are low, around 100W for SHS or 200W for PHS, mainly serving small DC appliances for lighting and communication (radios, mobile phone charging, or B/W TVs). Unlike Wind Home Systems, most Solar Home Systems do not support income generating activities, which enable a village to create productive services and jobs.

³ Reducing the Cost of Grid Extension for Rural Electrification, ESMAP (2000).

A third option is an electricity mini-grid, which can provide centralized electricity generation at the local level, using a village-wide distribution network. Mini-grids provide capacity for both domestic appliances and local businesses, and have the potential to become the most powerful technological approach for accelerated rural electrification. Mini-grids also offer an optimal solution for utilizing localized renewable energy resources. Many locations offer excellent natural conditions for the use of solar photovoltaic (PV), wind, or small hydro power. In recent years, renewable energy technologies (RETs) have evolved dramatically, in terms of prices, efficiency, and reliability. Today, conservative calculations of life-cycle costs show that hybrid mini-grids, powered chiefly by renewable energy with a genset – normally working on diesel fuel, are usually the most competitive technical solution. However, translating this great technical potential into real success stories on the ground has turned out to be extremely challenging. Deployment of hybrid mini-grids involves complex financial and organizational questions. The bottlenecks for the sustainable success of mini-grids are not the technologies, but financing, management, business models, maintenance, sustainable operations, and socio-economic conditions. Each community presents a cluster of characteristics and interests which will define the best technical solution according to local financial, social, and environmental terms.

This study addresses those rural communities for whom mini-grids are the most suitable solution and underlines the benefits of using a mix of technologies based on renewable energies, battery storage, and fossil fuels. It focuses on rural communities isolated from public grids and without any prospect of connection in the next 15-20 years; having a certain load demand and serving a concentrated group of 15 or more households. It seeks to identify key issues and lessons learned from previous hybrid mini-grid projects utilizing wind, solar, or hydro with a diesel genset back-up (Hybrid mini-grid usually having a capacity of up to 100KVA according to IEA⁴). The findings are based on analysis of existing documentation, as well as original research conducted by the Alliance for Rural Electrification (ARE).

Over the past few years the members of ARE have been involved in the implementation of hundreds of projects around the world. The lessons learned from these projects have helped create a new approach towards mini-grids. Whereas the traditional approach was centered on the technological aspects, the new one focuses on end-users, their needs and involvement, capacity building, markets, policies, financing, and allocation of responsibilities. This new approach does not lead to any master plan, but helps formulate solutions adapted to local conditions and national frameworks.

4 "IEC/TS 62257-9.2 ed1.0. Recommendations for small renewable energy and hybrid systems for rural electrification Part 9.2: Microgrids." IEC, 2006.

2. Hybrid mini-grid power systems: a technology primer

A hybrid mini-grid combines at least two different kinds of technologies for power generation⁵ and distributes the electricity to several consumers through an independent grid. Thus, the mini-grid is supplied by a mix of renewable energy sources (RES) and a genset, generally supplied with diesel, used as a back-up. It is a mature and cost-effective technology solution that provides high quality and reliable electricity for lighting, communications, water supply, or motive power, among other services. A hybrid power system functioning as an autonomous entity can provide almost the same quality and services as the national grid. Moreover, with the proper arrangements, it is technologically possible to connect a mini-grid to the national grid. In countries where the national grid may provide users with only a few hours of electricity a day and often suffers from blackouts, rural communities served by a hybrid mini-grid conceivably could receive with more reliable service than their fellow urban consumers.

2.1. Why a hybrid mini-grid?

Mixing different technologies with different energy sources provides competitive advantages compared with using a single technology. The combination of renewable energy sources with a genset has proven to be the least-cost solution for rural communities as the benefits and advantages of each technology complement each other. Since renewables operate “fuel free,” they are not subject to fuel price or supply volatility. However, renewable systems are non-dispatchable, which means that they depend on the availability of the resource at a specified time. Diesel gensets, in contrast, are dispatchable, and can deliver electricity when scheduled. By combining these two sources, a variety of shifting load profiles can be covered. Furthermore, the combination of various renewable sources simply makes sense in many scenarios. For example, a mix of energy sources can accommodate seasonal resource fluctuations, with solar PV collectors complementing wind power during the months with less wind, or picking up when hydro generation drops during the dry season. Where daily energy variations are concerned, solar energy has a production peak around noon, while wind power facilities can operate whenever the wind is blowing. Batteries add stability to the system by storing the energy for peak consumption when there is insufficient production from renewable sources (i.e., to offset lack of solar power during nighttime hours).

2.2. Differences between hybrid power systems, diesel genset power systems, and renewable energy power systems

There are two key factors to look at when assessing the suitability of a system, **the cost structure** of the system and the **quality of service**. Gensets and renewable energy technologies (RETs) have very different **cost structures**. Diesel gensets power systems have a very low initial capital investment in comparison with RETs. However, annual running costs are much higher due to the high operation and maintenance and fuel costs. Detailed analysis of the cost structures demonstrating the comparative advantage of hybrid multi-source power systems on a lifetime basis can be found in section 3.

Quality of service is the second factor. Diesel gensets provide energy on demand (assuming there is adequate fuel), which means that they operate according to the exact needs of the rural community. Renewable energy sources are subject to daily and seasonal variability, although energy production can be more or less predicted.

Therefore, systems running **100% on diesel fuel** have the advantage of being theoretically dispatchable on demand. However, in a rural context, the ability to run a genset does not always match the availability of fuel to run the generator. The isolated and sometimes inaccessible conditions in rural areas make the delivery of fuel to run a system powering more than 10 households for several hours a day very difficult. Local environmental impacts also have to be taken into consideration. Gensets are noisy and polluting, and have a direct health impact on users, especially when the generators are located next to the houses.

Power systems running on **100% renewable energy** must rely on a battery to store energy so that electricity is available even when the renewable sources are not for short periods of time (from a couple of hours to several days depending on the demand and battery capacity). However, in order to provide reliable quality of service (no blackouts), renewable energy power systems need to have a bigger generation capacity than

5 “IEC/TS 62257-4 ed1.0. Recommendations for small renewable energy and hybrid systems for rural electrification Part 4: System selection and design.” IEC, 2005.

fossil-fuel or hybrid power systems, in order to produce an excess of electricity to store. This can increase the energy price in comparison to a hybrid system, and reduce battery lifetimes as it may be subject to higher stress. Without a generator backup, substantial deviation from the anticipated daily load profile and/or unusually bad weather conditions have the potential to bring the system to collapse or necessitate load shedding.

Hybrid power systems typically rely on renewable energy to generate 75-99% of total supply (in some cases a diesel genset has been installed, but is hardly ever used due to the good performance of the renewable). The large share of renewables makes these systems almost independent and lowers the energy prices over the long term, and the diesel genset is used as a backup to assist in periods of high loads or low renewable power availability. The battery backup size can be lower and suffers less stress than in a 100% renewable power system, prolonging battery lifetime significantly and reducing replacement costs. Hybrid systems often are the least-cost long-term energy solution, capable of delivering the best services of the three alternatives.

2.3. Design of hybrid mini-grids

A hybrid mini-grid is composed of three subsystems: the production, the distribution, and demand subsystems⁶. Each subsystem can vary greatly in its components and architecture according to the availability of resources, desired services to provide, and user characteristics.

- **Production:** This subsystem includes the generation (RETs and genset), storage (batteries), converters (convertors, rectifiers, and inverters to convert DC power to AC), and management (energy management systems) components. The production subsystem determines the capacity of the hybrid system to provide electricity, and connects all the components through the bus bar (i.e. the electrical wiring connecting the different components together) at the required voltage (AC/DC) for the distribution subsystem.
- **Distribution:** This subsystem includes the distribution equipment. This subsystem is in charge of distributing the produced electricity to the users by means of the mini-grid. The primary issues are whether to use a distribution mini-grid based on DC or AC, and whether to build a single phase or three-phase grid. This decision will have an impact on the cost of the project and will mainly determinate the devices which can be used.
- **User or application subsystem or demand subsystem.** This subsystem includes all the equipment on the end-user side of the system, such as meters, internal wiring, grounding, and the devices which will use the electricity generated by the hybrid power plant.

The design of the mini-grid directly affects the cost structure of the project and determines not only the price of the energy produced, but also the quality of the services provided to the users. Detailed information on technologies and other design factors may be found in Annex 1. The early assessment phase of any successful design must integrate an analysis of the **local conditions** and the **rural community's needs**, and maximize **community involvement and support** in the design considerations. Local involvement is a necessity to reduce the chances of project failure and any negative image of renewables in the region.

Building community involvement requires a few separate steps:

- **Hold local consultations.** As end-users will be the ones using and paying for electricity, project success depends on their satisfaction as consumers. First of all, there must be a real demand for electrification from the village, and the people must welcome the project. Imposed solutions will only result in dissatisfaction and will lower the number of users. Promotional programs and monthly meetings will raise awareness among the beneficiaries.
- **Respect local organizational structures.** Each community has its own leaders who have a significant influence over local public opinion. Setting up a rural electrification committee with the regular involvement of local leaders can both increase local acceptance and provide priceless information for the overall design. For example, this committee can play a vital role in educating consumers, assessing electricity demand, and promoting the use of electricity. Local officials on the committee can also provide the project designers with key information, such as where to site the generation plant without disturbing local traditions. In Bangladesh, consumer meetings were held before the arrival of the electricity supply, helping to avoid costly and time-consuming disputes over rights of way and construction damage. In some cases, failing to include local leaders has been perceived as a threat to their position in the village, resulting in improper maintenance and even the disconnection of the system.

⁶ "IEC/TS 62257-2. Recommendations for small renewable energy and hybrid systems for rural electrification - Part 2: From requirements to a range of electrification systems." IEC, 2002.

acceptance and provide priceless information for the overall design. For example, this committee can play a vital role in educating consumers, assessing electricity demand, and promoting the use of electricity. Local officials on the committee can also provide the project designers with key information, such as where to site the generation plant without disturbing local traditions. In Bangladesh, consumer meetings were held before the arrival of the electricity supply, helping to avoid costly and time-consuming disputes over rights of way and construction damage. In some cases, failing to include local leaders has been perceived as a threat to their position in the village, resulting in improper maintenance and even the disconnection of the system.

- **Determine demand for services.** The installed capacity and design must be based on on-site demand forecasts that draw upon comprehensive surveys of potential consumers. Productive uses for electricity must be included as their technological specifications differ from domestic uses. For example, commercial load demand is mainly during daytime hours. Electricity services surveys will determine the load capacity, type of load (AC/DC) and phase required (single/three phase).
- **Support parallel creation of productive services within the project.** The availability of electricity to support carpentry, agriculture irrigation, telecommunications, or other local industries has a double positive effect. Growth in these sectors enhances the local economy, facilitating further services and connections, and stable electricity revenues.
- **Allow for future demand growth.** The number of user connections can be low in the beginning, especially in areas where no other projects have been installed previously; however, successful implementation and reliable service will increase the number of connections with time. Population dynamics also change once the village is electrified, and any growth in the local population will increase the connection points.
- **Look for improvement opportunities within the existing electricity supply and local infrastructure.** In villages with some kind of electricity supply such as diesel gensets, consumer behavior regarding electricity consumption is already established. This can be counterproductive for the hybrid power system and re-education is necessary. Other local infrastructure, such as access roads or water pumps, can be improved as part of the electrification project. This was the case in Kédougou in Senegal, where community centers and access roads were built, and the water pump system was redesigned to complement the hybrid power system⁷ (more information on these projects can be found in Section 4.1).

Lessons learned:

•	Diesel is expensive and difficult to distribute in rural areas. A 100% diesel mini-grid is not only more expensive than hybrid ones, but less autonomous if fuel availability cannot be assured.
•	Hybrid mini-grids utilize available local resources, making it less likely that power will not be available.
•	The projects must adapt to the local conditions, instead of the local people adapting to the project. To be successful, projects must respect the local traditions and local leadership structures.
•	Local involvement and participation is essential. Local leaders must be involved in the decision making and regular meetings with the end-users must be held. The long-term viability of the system depends on the users' satisfaction.
•	The parallel creation of economic services improves the sustainability of the project throughout the project lifetime and ensures revenues.

⁷ "PV hybrid micro-grid topology based on load management for village water pumping in Senegal." TTA, Vallvé X. 2008.

3. Cost Structures

3.1. Technology cost comparison

Hybrid mini-grids are in most cases, the least-cost, long-term option for rural electrification. Computer simulations allow for the evaluation of a great number of configurations and calculate quite quickly project configurations and costs, based on local situations. To illustrate this process, this study will show the costs of different hybrid configurations in comparison with a 100% diesel based mini-grid for a village in Ecuador. The final price of energy depends on the performance of RETs in accordance with local resources, the study will present a sensitivity analysis based on natural resources and price of oil. This will demonstrate the least-cost option not only for a specific location, but for any location, depending on local conditions.

These simulations have been done with the support of HOMER developed by the US National Renewable Energy Laboratory (NREL). This tool is widely used and constitutes one of the main instruments in rural electrification planning. It is especially indicated for economic and resource-sensitive analyses taking into consideration the basic technical specifications of the technologies involved.

The case study is based on the island of Bellavista located at the Jambeli Archipelago, El Oro province, Ecuador.⁸ The load profile and the natural conditions are site specific, which means that the results are only valid for this site and should not be extrapolated to other villages. However, the natural conditions are typical of many locations in developing countries and the diesel price estimate is quite conservative. The village has an average energy demand of 266 kWh/day, a peak power demand of 26kW, and the system serves continuously 24 hours a day electricity to 52 users including a school and a naval station.

The local natural conditions are:

Local natural conditions	
Solar insolation	6 kWh/m ² /day
Average wind speed	5 m/s
Hydro resources ⁹	80 L/s
Oil price	US\$ 0.70/L

Note that the installed capacities of each RET also have been simulated to provide electricity under a 30% demand increase scenario (346 kWh/day). The interest rate for the project is 4%.

The cost of the components are as follows:

Cost of components	
Genset	US\$ 400/kW
Small wind turbine ¹⁰	US\$ 2,120/kW
PV	US\$ 2,822/kW
Small hydro	US\$ 1,790/kW
Battery	US\$ 225/kW
Converter	US\$ 1,445/kW

8 "Tropicalization of feed-in tariffs: A preliminary study on the renewable premium tariff" Solano Peralta M. 2008.

9 The hydro resources are estimated for the case study, as originally there is no hydro estimation in the project

10 Fortis WindEnergy. Alize 10KW. This is an approximate cost and does not represent the retail cost of the manufacturer.

Under these conditions the total accumulated cost of the system is shown in Figure 1:

Figure 1: Total costs through the lifetime of the project ¹¹

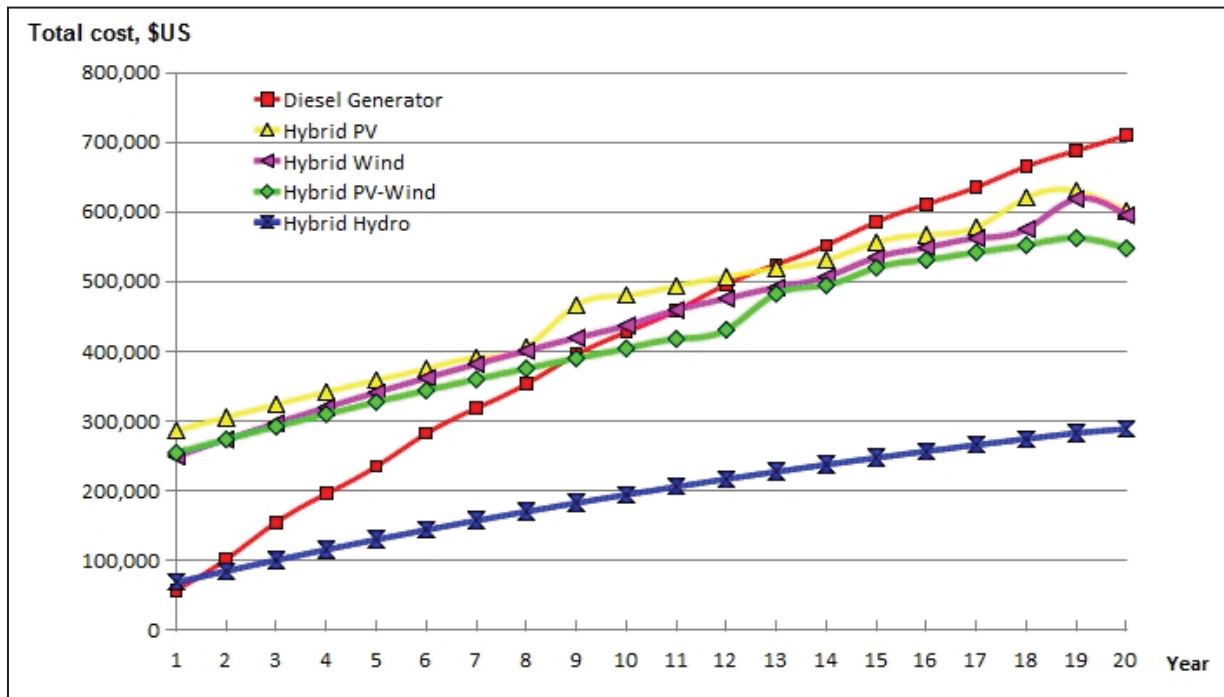

The diesel based mini-grid is the most expensive solution over the whole lifetime of the project. The fuel costs of diesel, the running costs, and the replacement cost of the genset every 3-4 years (25000 operating hours) offset the low initial investments. The genset size considered is 30 kVA.

The small hydro-diesel hybrid system is by far the least-cost solution. No other calculations including small hydro are shown here as none of the other options is economically sound in comparison with a combination hydro/diesel mini-grid. To include PV or small wind would only increase the initial capital cost and would not offset the avoided fuel costs enough for the investment to be cost-efficient. However, this clearly shows that small hydro is the best option as long as there is a river with sufficient discharge. It will take the hydro hybrid power system only 1 ½ years to break even with the diesel-based mini-grid.

The photovoltaic-diesel hybrid and the small wind-diesel systems have similar costs, although both are still cheaper than diesel mini-grid on a life-cycle cost analysis. This similarity is due to the fact that in this case study, the solar insolation is better than wind speeds. As shown later in the sensitivity analyses for natural conditions, wind technologies are generally cheaper than solar if the wind resources are good enough. However, the profiles present two significant differences. First, the operating costs are higher for the wind hybrid power system than for the PV one. This is due to the fact that this power system relies more on diesel (17%) than does the PV hybrid (8%). Second, the battery replacement costs are higher for the PV hybrid power system, in which the battery needs to be changed roughly twice as frequently as in the wind power scenario, after 8 and 16 years. This underpins how the use of a battery can influence its lifetime. The break-even points of both are 12.7 and 11.2 years, respectively, and the difference in costs at the end of the lifetime are around 16% below the diesel-only option in both cases.

The last configuration, a hybrid power system combining PV, small wind, and a diesel genset is the least-cost solution (beside the configuration with small hydro). This combination benefits from both technologies. It has a low consumption of diesel fuel, as it only needs to run with 9% of fuels instead of 17% in the small wind hybrid. In addition, the battery has a prolonged lifetime of 13 years. The break even point in this case is 8.7 years, less than half of the project lifetime. The final costs are also 23% lower.

11 Source: Alliance for Rural Electrification.

Table 4. Sensitivity analyses for model configurations

	Genset Capacity	RET Capacity	RE Share	LCOE* (US\$/kWh)	Break-even point
100% diesel	30 KVA	-	0%	0.538	-
Hybrid PV	20 KVA	60 kW	93%	0.456	12.7 years
Hybrid Small Wind	20 KVA	60 kW	83%	0.451	11.2 years
Hybrid PV-Small Wind	10 KVA	PV - 35 kW SW - 20 kW	91%	0.420	8.7 years
Hybrid Small Hydro	10 KVA	26.8 kW	97%	0.219	1.5 years

* Levelized costs of energy / Source: Alliance for Rural Electrification

3.2. Adjusting the model for varying natural conditions

The Ecuador case study was based on site-specific natural conditions and a fixed diesel fuel price. However, the results are actually too site-specific to demonstrate clearly that hybrid power systems are the least-cost option over the long-term for most locations in developing countries. For this reason, several sensitivity analyses based on different natural resource conditions are presented. Starting from the same “human” conditions (load profile and cost of components), different natural conditions have been extrapolated showing the range of possibilities found in other countries. Mini-hydro is not included in the following sensitivity analyses. The two first analyses show the least-cost options with a fixed diesel price and the first figure taken (\$0.70/L) is the price used in the above case study. The case study situation presented below is marked as a small white circle in the graph at 5 m/s wind speed, and 6.05 kWh/m²/d solar insolation.

Figure 2. Optimal System Type at different natural conditions with fixed oil price (\$ 0.70/L)¹²

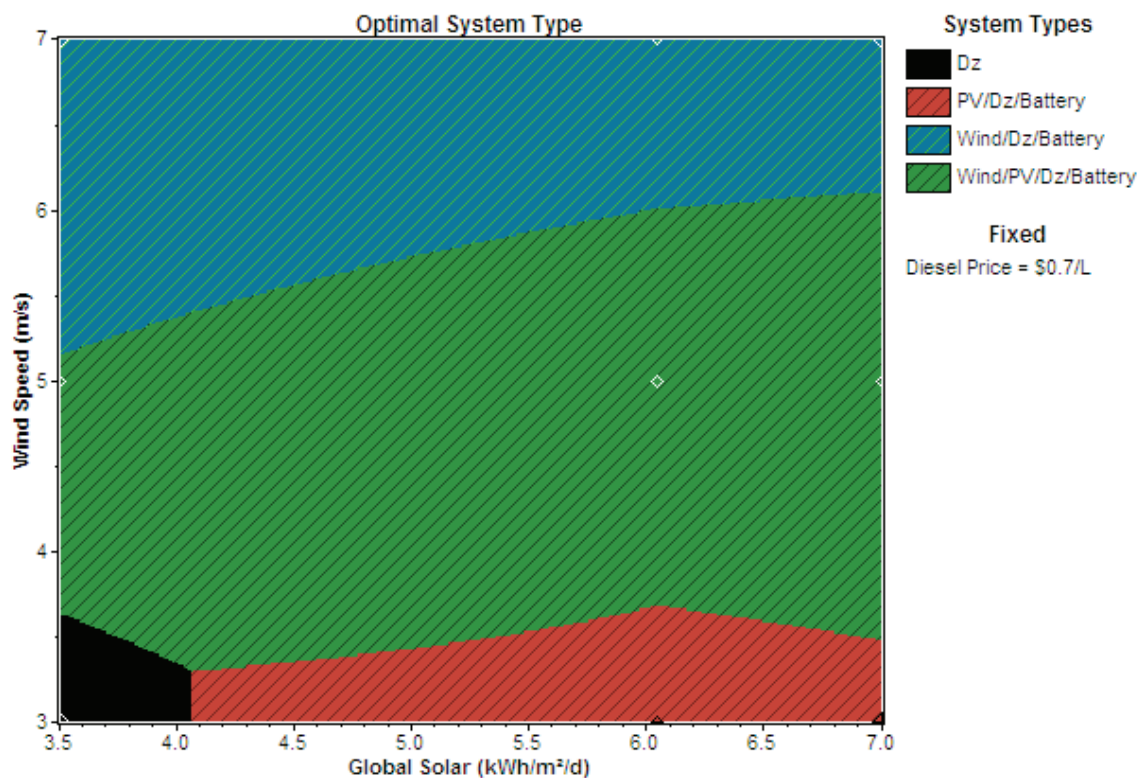

12 Source: Alliance for Rural Electrification.

Figure 2 demonstrates that a power system only fed by diesel generator (Dz) is only cost competitive when the wind conditions are below 3.4 m/s, or with an insolation under 4.1 kWh/m²/day. These two values are in accordance with the ones given by manufacturers and project developers around the world about the minimum natural conditions for their technologies to be feasible. In the case of small wind energy, the explanation is that the cut-in speed is normally around 3.5 m/s. This is a minimum value for specific wind speed at specific time (wind must blow at a minimum speed of 3.5 m/s for the turbine to produce electricity). The wind speed in the graph is a yearly average which means it is possible for a wind power system to be cost-competitive even if average natural conditions are below the cut-in speed. In this scenario, the distribution of wind speeds throughout the year may result in long periods when wind speeds blow at 7 m/s or more, making for average values of 3.5 m/s,

In tropical countries the installation of photovoltaics is almost always a good solution. In the least-cost figure PV can be found for all the insolation values; even with only 3.5 kWh/m²/d, PV is still cost-effective if combined with wind. This means that even with low resources it is still a good idea to install PV. At high wind speed situations, the PV is no longer needed since the performance of the turbines is high enough to power the whole system.

The next graph has been calculated to factor in higher prices of diesel fuel. This situation is likely in many locations where the isolation of the village increases fuel distribution costs, or when international oil prices are as high as they have been in recent years. The diesel price in Figure 3 is set at US\$1.30/L. At this price a diesel mini-grid is NEVER the least-cost option. From US\$1.00/L, a power system that runs only on diesel is never cost competitive.

Figure 3. Optimal System Type at different natural conditions with fixed oil price (\$ 1.30/L)¹³

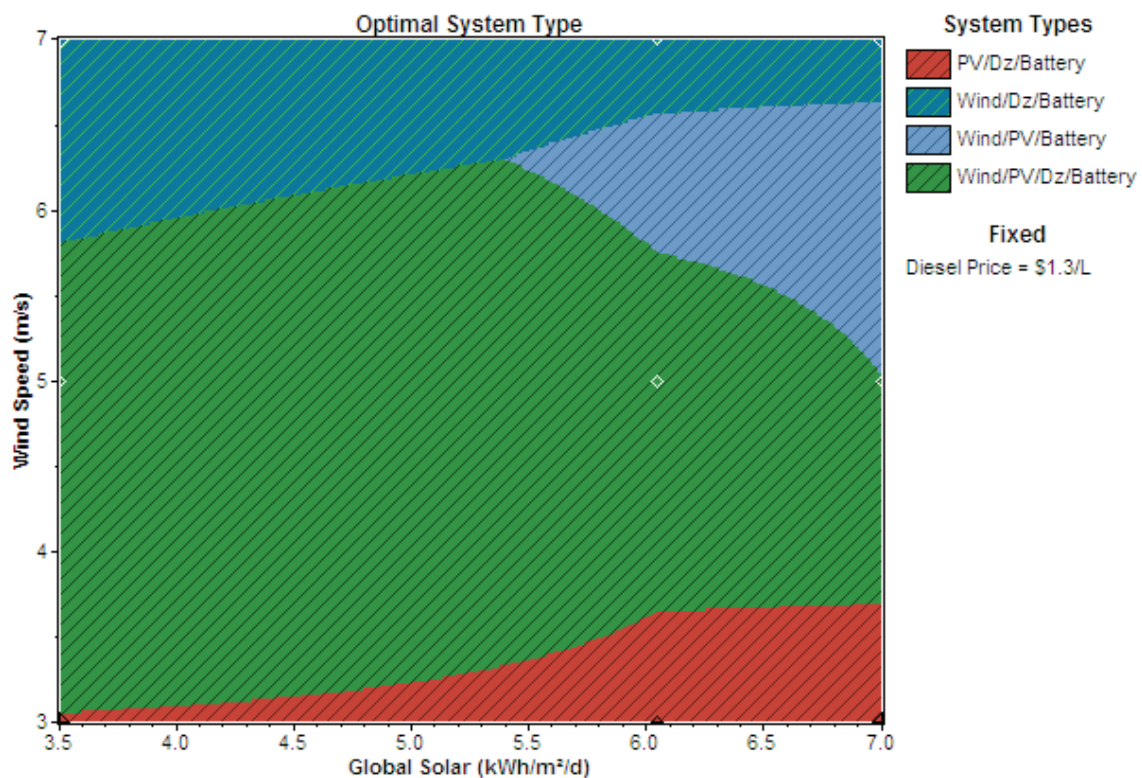

This graph raises another significant point. If the wind conditions and insolation are high enough (as shown in the light blue area), then the system does not require the use of a diesel genset as the least-cost option. However, at really high wind speeds, it is more economical not to use photovoltaics and to rely on diesel for the periods when wind is not available. This is due to the high capital cost of PV, which requires maximal production to make the investment feasible.

13 Source: Alliance for Rural Electrification.

3.3. Adjusting the model for varying diesel fuel prices

Figure 4 shows a different sensitivity analysis comparing a system running only on diesel and a PV-wind-diesel hybrid mini-grid. The hybrid configurations in figure 4 have been proved to be the least-cost solution under most natural conditions. However, the criteria of diesel price included this next graph demonstrates how prohibitively expensive a diesel power system gets when the fuel price increases from US\$0.70 to US\$1.50/L.

Figure 4. Accumulative costs comparison at different oil prices¹⁴

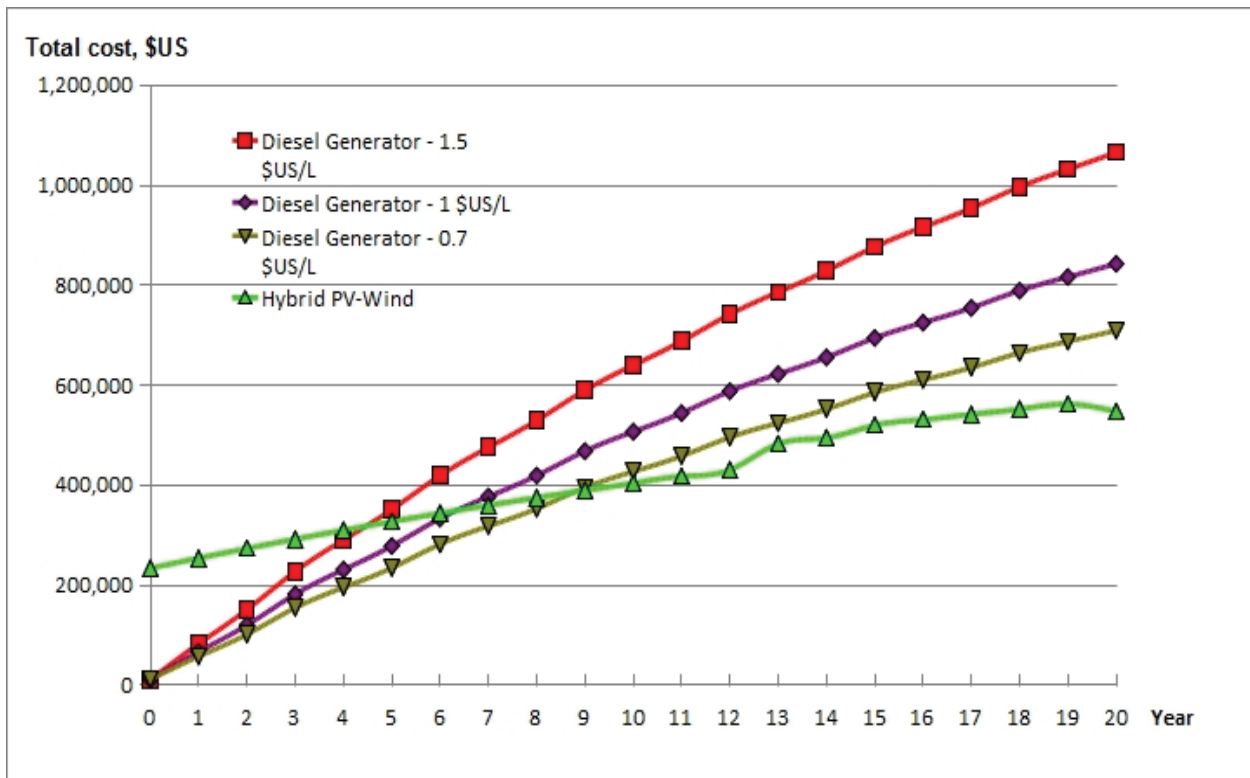

The LCOE in these cases are:

	LCOE (US\$/kWh)	Break-even point
Hybrid PV-wind	42.0	-
Diesel generator – US\$0.70/L	53.8	8.7 years
Diesel generator – US\$1.00/L	63.9	6.4 years
Diesel generator – US\$1.50/L	80.8	4.4 years

Note that the Levelized Cost of Energy (LCOE) difference from the hybrid PV-wind-diesel with the 100% diesel at US\$1.50/L is almost double. Also significant is the break-even point at only 4.4 years. This chart shows significant benefits to cost projections depending on the diesel price at conservative natural conditions. If the natural conditions were more favorable, the prices of a renewable-diesel hybrid mini-grid would decrease even further, becoming more cost-effective.

14 Source: Alliance for Rural Electrification.

Lessons learned:

•	Diesel is expensive and difficult to distribute in rural areas. A 100% diesel mini-grid is not only more expensive than hybrid ones, but less autonomous as fuel availability cannot be assured. Hybrid mini-grids utilize available local resources, making it less likely that power will not be available
•	Hybrid mini-grids typically are the least-cost solution among mini-grids for most locations and natural resource conditions over the long-term, and they provide the most reliable service.
•	A long-term investment perspective on hybrid mini-grid is essential for developing successful projects.
•	The estimated lifetime of components and replacement costs play a crucial role on the cost structure of the systems.
•	Increased diesel fuel prices encourages renewable energy use, and less reliance on back-up gensets.

Hybrid power systems clearly present an important financial advantage on the life time of the system and are imposing worldwide as a credible alternative to other off-grid power systems, mainly diesel fed. However, their specific costs structures (high upfront capital and lower O&M costs) raise many challenges on financing and operation schemes. Their relatively complex O&M requirements as well as the necessity to keep them up and running for long periods to make them attractive demand long term schemes that will, however, also have global benefits on the local community and economic situation.

4. Business models for rural mini-grids

The definition and classification of business models for rural electrification is challenging. More specifically, the question of the criteria to use in these classifications is crucial. However, it is a very important exercise since a key for success of mini-grid systems is the local institutional arrangement determining who invests, develops, owns, and operates the systems.

Most of the typologies used either by the World Bank, the UNDP and several others are based on ownership, whereas others include subsidies and a few integrate the technologies. All these criteria have their relevance; however, ownership is clearly the dominant and most decisive element on what to base a typology of business models. Ownership is very often closely linked with the actor who has been responsible for the implementation of the project and who is going to be responsible for the O&M&M. In any case, models should be chosen based on local circumstances. This is especially true if a private sector party is willing to take the lead.

Through section 4, the study will describe the different types of business models and illustrate them with case studies from ARE member organizations. The study will also try to underline the main points discussed throughout the first parts.

Before entering into the description of the business model, it is important to understand that a specific ownership does not determine responsibility for the operations and maintenance of the systems.

The main management and operation contracts options include:

- An authorization arrangement when the system is globally managed by a public authority, utility, or private company that appoints some individuals to operate and maintain the system on a daily basis.
- A contracted operation when the system owner contracts the operation of the system to an individual or enterprise that assumes full O&M responsibility, and may even collect revenues and pay for fuel and other consumables.
- A leasing contract where the tangible assets of the system are leased to the system operator, who can be an individual, a community or an enterprise. The system operator takes on a greater degree of responsibility for medium-term system maintenance and recovers its investment through the fees collected.
- Full ownership transfer to the system operator or the community.

4.1. Community-based model

Community-based mini-grid management mostly occurs if a mini-grid in isolated areas does not attract private-sector or utility interest. In this case, the community becomes the owner and operator of the system and provides maintenance, tariff collection, and management services.

Figure 5. Management Mechanism in surveyed villages¹⁵

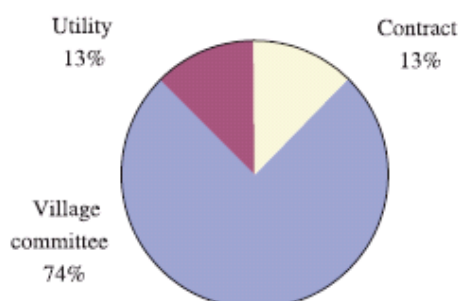

Community-based organizations are a very common model used with renewable energy mini-grids in developing countries, since interest from the private sector or utilities remain limited. In Latin America, many small rural suppliers have the legal status of cooperatives while some of the medium-sized systems are co-owned by municipalities or prefectures that own and operate their own systems.¹⁶ In China, as shown in Figure 5, ownership is frequently at the village level.

In fact, in many countries, the community model is the only option in remote areas. Compared to the alternatives, the owners and managers in a cooperative or community-based organization are also the consumers and therefore they have a strong interest in the quality of the service and a real presence in managing it. Community-based organizations increase community self-sufficiency and self-governance and often are more efficient than utilities, which tend to be bureaucratic. Finally, they generate O&M&M jobs in the community and offer the possibility to apply tailor made tariffs.

¹⁵ "China Village Power Development Guidebook" UNDP, GEF, 2005.

¹⁶ "Electrification and Regulation: Principles and a Model Law." The World Bank, 2006.

However, this type of socio-business structure faces many challenges. First of all, local communities usually lack the technical skills to design, install, and maintain the systems; the business skills to develop sustainable tariff plans and additional added value to increase the outcomes; and the financing resources. This often results in technical and financial failure. Therefore, a community-based model requires substantial technical assistance with regard to the system design and feasibility studies as well as training in operation and maintenance and assistance in management support during the lifetime of the project.

Second, the organization or committees that typically are formed to manage the system are often vulnerable to the “tragedy of the commons,”¹⁷ particularly if the system does not include individual meters, or other devices to measure and limit the consumption of each user and avoid potential conflicts within the community. In designing a project using a community-based model, the potential for social conflict has to be addressed, via sociological, technical, and economic approaches. Hence, the social shaping of the committee which will be in charge of the system management is important, as are the rules of leadership. Appropriate tariff structures and technical controls are also required to avoid abuse of the system and collective failure. Finally, in some cases cooperative managements have been subject to corruption.

Therefore, it is clear that if a community-based organization is to be successful, it requires time, nurturing, and capacity building. Sometimes, it may be more efficient to involve a private or public entity that will take on the technical aspects and therefore limit the community organization’s role to monitoring. This has been the approach taken by the Energy Services Delivery (ESD) project’s off-grid village hydro systems that operate in Sri Lanka. The systems are owned and operated by community-based cooperative societies, while the government keeps some control over technical specifications and safety in its role as a provider of subsidies.

Trama TecnoAmbiental (TTA), a member of the Alliance based in Spain, has a wealth of experience in the implementation of RE mini-grid in developing countries. In particular, TTA has worked in the development of projects based on a community organization business model. Two projects are detailed here.

The first project was undertaken in the village of Akkan in Morocco. The system combines 5.76 kWp PV, with an 8.2 kVA single-phase diesel generator, and a battery bank with 24 elements (48V) for a 4 days of back-up capacity. Renewables are producing 95% of the power. In addition, the project also included a very small micro-grid for three users (480 Wp of PV and 7 kWh of batteries) and one SHS for one user (160 Wp of PV and 2,4 kWh of batteries). The entire project includes 35 connections: 31 on the larger micro grid (27 households + 4 community facilities and public lighting); 3 households on the smaller grid; and 1 household on a SHS. In order to make the tariff and the system viable, TTA works with an “Electricity dispenser” a tailor made power and energy limiter and meter attached to each connection. The influence of the energy dispenser and training on load management has resulted in no black-outs.

The second project was undertaken in Diakha Madina Senegal. The total PV installed capacity is 3.150 Wp with 42 modules of 75 Wp and with a battery composed of 24 elements (48V) for a total autonomy capacity of 4 days. The backup generator has a nominal power of 3,6 KVA but the solar fraction of the system is as high as 99%. The hybrid power system for this project was installed for public uses and supplies the health centre, the street lighting system and the village water pump for an energy demand 10 303 Wh/day. The daily load (power and energy) served to the health centre is limited by an electricity dispenser. The battery is sized to the total load excluding the pump, which only operates when the battery is full and there is a surplus of PV generation. Hence, in addition to the water availability, the water tank is used to buffer the stored energy and to modulate it to the daily load.

In both cases, TTA undertook the implementation work and the creation of the business plan. The investment costs were financed by grants coming from different organizations which covered 80% of the initial investment. The other 20% were financed through a contribution from the village in labor costs and cash.

17 The “tragedy of the commons” refers to a dilemma describing a situation in which multiple individuals, acting independently and solely will ultimately deplete a shared limited resource even when it is clear that it is not in anyone’s long-term interest for this to happen.

In the case of the Moroccan project, operation, maintenance, and replacement costs are financed through the monthly flat tariffs paid by the users, which was fixed according to a pre-agreed maximum daily energy available to be consumed (two different levels offered). The tariffs established and approved are 50Dh (~\$5,8) and 100Dh (~\$11,6) monthly for 275 and 550 Wh/day. They have been planned for a typical yearly budget of nearly \$1.965, that also includes saving for battery replacement.

Binding contracts for the electricity service were signed between the community association and each user. According to this contract, in case of non-payment, the user would be disconnected and would have to repay his debts and a reconnection fee to be reconnected. Moreover, the users have to pay a substantial initial connection fee which gives to the project developers a clearer idea of their ability and willingness to pay.

In both cases, the community owns the power plant and the local grid. However, in the Moroccan case, a legal entity, a local association, was created to be responsible for the O&M, the replacement, and the fee collection. The maintenance responsibilities were subcontracted to a local technician. According to village feedback, users have actively participated in the committee's organization and most of them trust the management of the collective funds as well as the O&M of the system. In the Senegalese case, a local leader is responsible for the collection of funding mostly from external sources, the O&M, and for the component replacement, whereas contracted trained local staff makes regular visits to check the system and perform and necessary repairs.

In terms of capacity building and trainings, TTA has a well established policy automatically included in their project procurements. Training is delivered in two stages. First, during the whole project preparation and implementation, three levels of training are delivered: to the end users on the possibilities and limitations of the system and on the uses of electricity, to the structure which is going to be in charge of the system first O&M, and to the local technicians who will ensure the hard O&M work. Second, after about 6 months, TTA visits the project, answers to the problems that have appeared and completes the trainings. Hence, the different local parties receive a first "theoretical" training and a second one at the light of the actual operation of the system. In these precise cases, training was part of the projects itself and was foreseen within the whole project financing. This should be compulsory from the donor/commissioner side to ensure project sustainability. In addition, in the framework of the Moroccan project, TTA has realized another full project assessment after a year of finance thanks to funds from a Spanish University and a European project.

According to TTA, this model has been very cost effective, has reinforced the governance structure within the community, and has helped develop local capacity building. The influence of the electricity dispenser (meter with energy limiting functions) and of the training they received on load management has resulted in smooth operations. The monthly fees were calculated correctly, within the user's willingness to pay but sufficient to cover the ongoing costs and put money aside for future components' replacement. Incidences of non payment are quite rare and if they occur (as did happen in Morocco) the community usually takes care of the fee for the household that cannot afford to pay. Finally, the degree of satisfaction is high and local demand continues to increase slowly, which means that the consumption categories were correctly estimated.

According to TTA, however, this model and project suffer from two major concerns, which make them quite vulnerable over the long term. First of all, in both cases, despite the training provided and the small local structure set up for O&M, if a major technical problem occurs, the community is unlikely to be able to resolve the issues or quickly find replacement components. In general, the model's institutional solidity has yet to be proven if a managerial or technological problem arises over the long run. Moreover, there is also the risk that the funds that have been saved for future replacements could be utilized instead for other short-term needs that may arise in the community. It is the mission of the local committee to ensure that this money is spent for the right purpose, but there is a range of local priorities in these villages. In the Moroccan project, for example, some of the savings have been reallocated towards other purposes.

To conclude, TTA underlined that the integration of a local private company to operate and manage the system, instead of the community, at least from a technical point of view but also regarding the financial responsibility, might be a way to avoid such problems.

Lessons learned:

- Involve the local community as much as possible and as soon as possible through financial or in-kind participation, connection fees, and the village committee.
- Binding contracts are needed to secure local involvement and for the sake of the operation. Penalties enforcing this contract are fundamental.
- Flat-fee tariffs with different categories are a good option for less wealthy end-users. The tariff rates must supply O&M funds, as well as replacement costs.
- Community-run mini-grids have proved to be successful and this type of organization can have many positive impacts on the community itself in terms of self governance and local buy-in into the electrification system. However, this approach also needs a long preparation period and much technical and social capacity building to compensate the lack of skills and the potential for social conflicts. Therefore, the introduction of another partner – either private or public – to take over some aspects is preferable.

4.2. Private sector-based model

Private sector-led mini-grids are another possibility, often when government support raises an interest, but sometimes also spontaneously. In this case, it is naturally around the private sector that will be structured the business plan, unless the ownership of the systems is transferred after implementation to another actor. In general, a well done rural electrification program must follow an economic logic and be able to attract private companies. In fact, more and more private sector service providers enter into rural energy market through subsidy schemes or regional concessions.

There are around 700 electricity-generation plants in developing countries that have been financed, constructed, and operated by independent power producers.¹⁸ For isolated mini-grids, system location and scale, income profiles of potential customers, and available subsidies, among other factors, dictate whether a project can attract private investors/operators.

Figure 6: Evaluating risk and return¹⁹

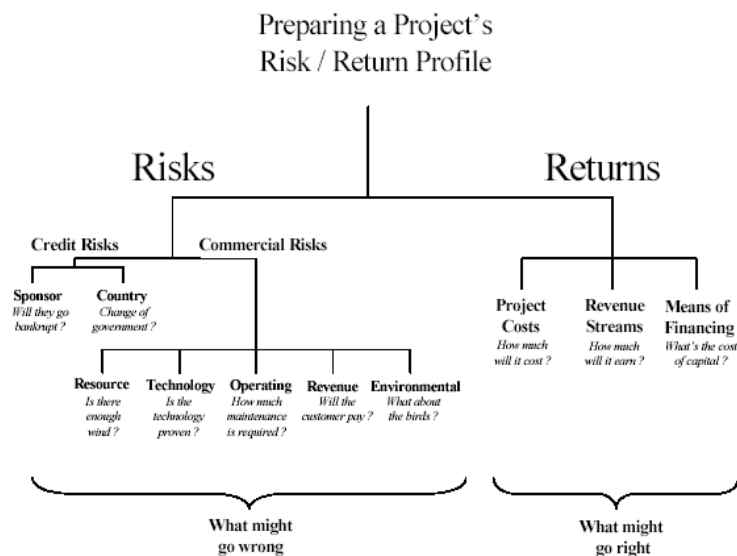

18 "Regulatory Review of Power Purchase Agreements: A Proposed Benchmarking Methodology." ESMAP, 2008.

19 Source: "Risk and return profile," ARE Working Group on Legal and Policy frameworks, Anjali Shanker, IED, 2009. http://www.ruralelec.org/fileadmin/DATA/Documents/07_Events/WG_Legal_Framework/IED.pdf

A private-sector model can take different forms according to the ownership of the system and the mini-grid, the type of contracts (with end-users, the utility), and the type of subsidies. However, the principal advantage is that it usually provides electricity more efficiently than any other model. If a business plan is well structured, companies are also able to ensure long-term O&M&M and have the technical ability to address urgent problems and replacement issues. Moreover, the private sector might have the investment capacity that is much needed in rural areas. Finally, in developing countries many private sector companies involved in the generation of electricity from mini-grids have a local interest in providing electric power services and therefore an added motivation for their own involvement. Compared to public utilities, private firms may be better able to navigate political interference.

However, given the situation of most rural areas in developing countries, the private sector cannot generally be expected to build up a system and/or serve rural populations without some form of public financial support. Experiences in many developing countries show that it can be quite difficult to find enough interested and qualified companies to bid for rural electrification concessions. Therefore, the interest in these types of long-term projects usually comes from smaller local private companies, which tend to have limited technical skills and financial resources.

Several options exist to encourage private-sector interest, as detailed in the next section. However, in general, it is fair to say that the private sector model is the approach with the greatest potential, taking into account the capacities of private companies and the needs and markets of developing countries, but this model is also the hardest to set up.

One good example of a private sector-based rural electrification program is the NPC SPUG program facilitated by the International Finance Corp. (IFC) in the Philippines.

Before this program, the National Power Corporation's Small Power Utility Groups (NPC SPUG), the national utility's group holding the electricity supply monopoly in the islands and rural areas of Philippines. The services provided by these companies were characterized on the generation side by poor reliability and high costs (and therefore high level of subsidies); and on the distribution side by less than efficient distribution utilities or rural electric cooperatives.

To address the challenge of providing sufficient power to meet current and suppressed demand in an efficient and sustainable manner, while reducing the costs and subsidies, the Philippines (with the support of the IFC) introduced a private sector participation scheme for power generation based on privatization of generation, transparency in pricing, and true cost recovery measures. Under this new scheme, distribution utilities/electric cooperatives are required to source out their power supply requirements and private sector companies have gradually taken over the role of generating power.

The introduction of these New Power Producers (NPPs) in generation is going through a competitive selection process over 15-year local concessions anchored by a power supply agreement (PSA) with the electric cooperatives. NPPs are selected based on the lowest true generation cost proposed.

The NPPs have two sources of revenues: from the cooperatives under the PSA at the "Subsidized Acceptable Generation Rate" (SAGR) and from the "Power Sector Asset and Liabilities Corporation," which represents the end-users, under the form of an output-based aid subsidy aiming at covering the difference between the true generation costs and the price paid by the end-users. The OBA subsidy is provided by the utility and was, after the first call for tenders, decided at 12.8USc/kWh for the first island package and at 13.9USc/kWh for the second (instead of 23 USc/kWh on average before). All payments to investors are on a variable basis and linked to the output produced without any take or pay obligations.²⁰

20 In a take-or-pay contract, the off-taker either takes the product from the supplier or pays the supplier a penalty. Up to an agreed-upon ceiling, the off-taker has to pay the supplier a penalty (which is usually lower than the product's price) even for products it does not take.

Figure 7. PPP transactions in the SPUG projects, Philippines²¹

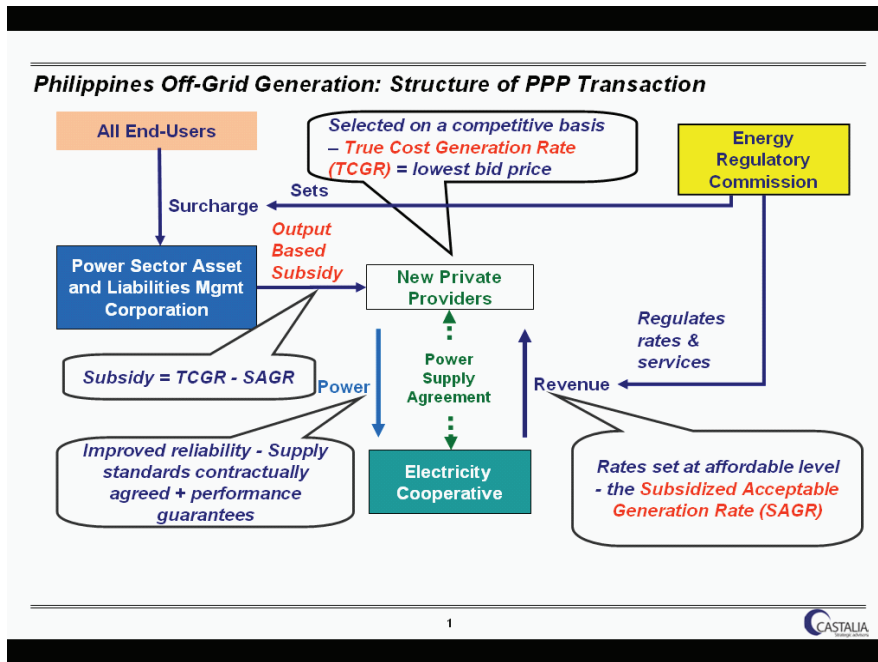

Private generators have the option to lease NPC-SPUG's existing generation assets or construct their own generation facilities.

After the two first packages which were covering three islands, and one island, respectively, 26 investors registered for first bidding competition and 15 for the second. The prices proposed were much lower than former prices and therefore the level of subsidies also dropped.

According to the IFC, several key factors have made this success possible:

- The project developers remained technologically neutral in order for the private companies to propose their own solutions with their own costs. No renewable energy project has been proposed so far, showing once again the lack of awareness and knowledge of these technologies even when they could impose themselves naturally.
- They tried to create a transaction structure that served consumers and balanced the interests of the off-taker and the private provider on a sustainable basis (OBA).
- A major effort was made by the program promoters (the Energy ministry and the IFC) to set up information, communication, and education programs for national and local stakeholders' right from the project's inception. The objective was to present the off-grid islands as a niche market in the Philippine power sector and therefore to push a new set of players from the local private sector to invest in the projects by offering them the right incentives, and by convincing them of the strong potential local growth prospects once power infrastructure constraints were addressed. This required a long and patient process to get local authorities and cooperatives as well as the private sector on board.

After the preliminary successes, project organizers are looking to attract more local players and provide a continued supply of private power partners. Finally, it is interesting to notice that the program from the outset aimed at phasing out the subsidies as shown in the figure 8.

21 Castalia Consulting, USA.

Figure8:
Regulatory
framework
of the
Philippines
program : 22

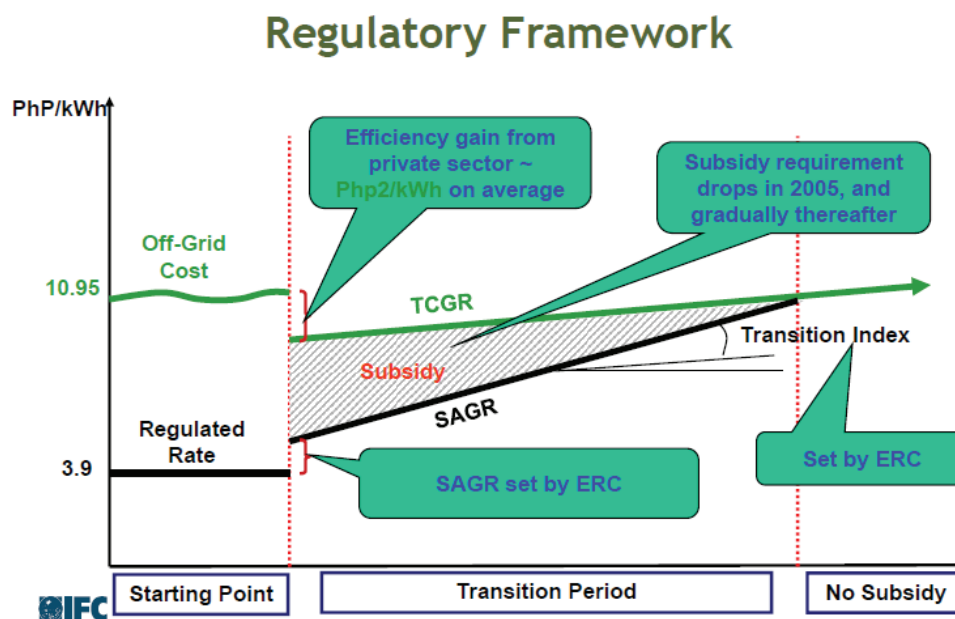

Therefore, the objective is to reach a point where the installation would become commercially viable, especially thanks to a strong private development program.

Lessons learned:

- The operator should be the main designer of its system and its technology. The main project driver should be costs and quality, including consumer health and the environment.
- Output-based aid subsidies and long-term concession, when well designed, are attractive schemes to increase private sector participation.
- A certain level of standardization of the administrative procedures (and more especially PPAs) and bidding process is advised to reach a fair degree of replication and economies of scale.
- Strong and targeted marketing around the call for tenders and the program are critical to increase private sector participation.
- If renewables could naturally compete on a costs basis with fossil fuel alternatives, this type of program show that they do not. Therefore, education and awareness campaigns are justified to support their development on the basis that they are cheaper and more sustainable options.

4.3. The utility-based model

According to the World Bank, utilities are the most common driver for rural electrification in developing countries.²³ The principal advantage of this approach is that the primary responsibility lies with an experienced party with the financial resources and technical capabilities to implement and manage the project. Due to their public or quasi-public position, utilities also directly benefit from a privileged legal position and have better access to financing mechanisms that they can sometimes apply themselves (i.e. cross subsidies). Moreover, their centralized position and large stock of spare parts give them the possibility to offer extensive maintenance services. Some experts consider that this model is more likely to be successful because of economies of scope and scale that utilities can generate, but also in the light of their access to financing. In fact, there are several examples of well-run public utilities responsible for rural electrification programs in Thailand, Tunisia, and Morocco. However, the success of these programs usually rely more on the innovative business approaches adopted by the utilities, rather than on the traditional public-oriented programs.

The utility model is also raising skepticism. If utilities were to be the key to full access to energy in developing countries, electrification rates would significantly outpace population growth, which is not the case for most Sub-Saharan countries.

On the contrary, the liberalization of the energy markets that has taken place in most developing countries has tied utilities to market-driven priorities, and running remote, low-revenue mini-grids in rural areas of developing countries is certainly not a priority for many utilities. Many of them are also inefficient and bankrupt, and their O&M costs are in general much higher than any other project developers. Finally, the utility model runs the risk of being rejected by the local communities and unresponsive to local circumstances (i.e., involvement of the end-user, development of local technical capacities). Hence, rural users may see a project run by the capital city-based utility with skepticism and refuse to assume any ownership. This may result in a diminished willingness to pay, and may eventually lead to financial failure. In brief, the best advantage of utilities (centralization) is also its biggest shortcoming.

Last but not least, utilities are often driven by political agendas. This can be an advantage if one considers that full access to energy should be a political mission and that the utility should be the armed branch of this political will. Utilities may, however, be at a disadvantage if influenced by the short-term thinking or priorities of politicians. Political agendas have rarely offered sustainable long-term solutions to energy access.

Confronted with the numerous changes happening within the energy markets, and in particular, the unbundling between generation and distribution, utilities increasingly may have an interest in rural electrification. However, the future of rural electrification probably lies in a mix of the different systems, with the utility positioning itself as partner for the private sector and community-based organizations.

4.4. Hybrid business model

Hybrid models try to combine different approaches to benefit from the advantages of each of the models and to minimize shortcomings. They can therefore be quite diverse, tending to adopt the different types of O&M contracts earlier and combining different ownership structures (i.e., one actor owns the grid, the other the generation capacity).

For example, a utility or a private company implements and owns a renewable energy mini-grid power system, a community-based organization manages it on a daily basis and a private company provides the technical back-up and management advice. The collaboration enjoys the technical expertise and experience of the utility with the possibility to realize economies of scale in the realization of big infrastructure works (grids), the local involvement of the community-based organization, and the financial investment, technical expertise and efficiency of a private company.

Another approach involves a partnership between the national state-owned utility and local distribution entities. Under this arrangement, the utility typically constructs medium- and low-voltage lines and then sells power at a wholesale rate to local distribution entities, which may be private operators, cooperatives, or affiliates of the national utility. These entities, in turn, resell it at retail prices. This approach, sharing responsibilities and combining expertise, was used with great success in Vietnam during the 1990s. It often produces cost savings for the utility, which does not manage the system, the local service agents or operators being usually better at providing this service.

²³ "REToolkit: A Resource for Renewable Energy Development." World Bank, 2008.

One of the best examples of the mixed business model comes from Sunlabob, an ARE member based in Lao PDR. The power system presented here combines a 12 KW small hydro generator with a 2kWp PV system and a 15 kVA diesel generator (supposed to run on jatropha in the future). The 3-phase grid mainly operates on the hydro generator. This hybrid mini-grid feeds 105 households with a daily peak load of 8kW, this peak remaining for 3-4 hours per day. The system is almost entirely working on renewables, since the energy from hydro and PV is large enough to cover the needs and therefore the genset is almost never used. Moreover, batteries are not included in the system since hydro power is available for night loads, which has significantly reduced the costs of the system. Solar PV was added for the dry season and the genset to address any unexpected demand.

Sunlabob participates in a very specific PPP where public partners funded the fixed assets (public infrastructure and village grid), even though the ownership was then legally transferred to the village community whereas Sunlabob, as the private local energy provider, financed the moveable assets. Consequently, Sunlabob owns and is responsible for the power generation system and charges a fee to each household based on its consumption. The company employs two villagers to operate the system and collect the fees. This helped them to reduce their administrative costs and increase their efficiency since the salaries of these employees is linked to the fees they collect. Even though the mini-grid is officially owned by the villagers, the maintenance is also carried out by Sunlabob. Through this project Sunlabob has committed itself for a 25-year PPA with the village. This gives it an internal rate of return of around 15%.

Sunlabob collaborated early on with a local NGO on both the feasibility study and involvement of the local community. The NGO which acts as their main interlocutor in the dialogue with the villagers, and also focuses on the development of income-generation activities to maximize the benefits of electricity access. The community also participated in the investment with in-kind work for the construction and therefore remains vested in the ongoing successful operation of the system.

Figure 9: Lao project's structure:

Source: Sunlabob

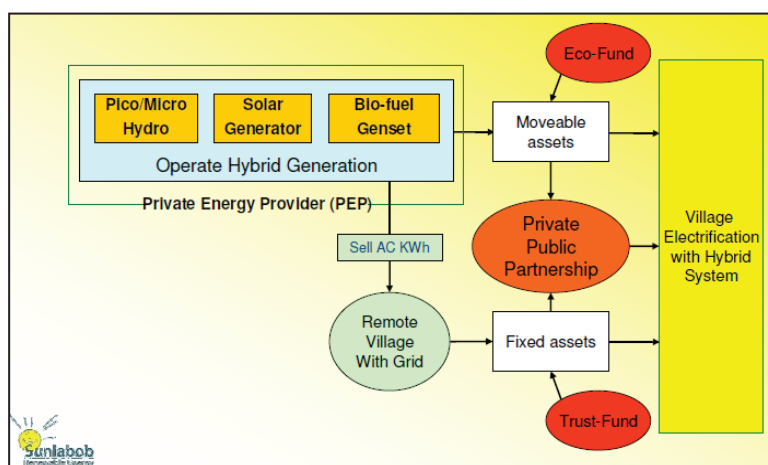

Without the public support to finance the needed grid infrastructure, this project would not have been possible, since the prices to recover the project costs would have been too high for the rural population. However, the project is currently running without any kind of public support.

Consequently, the electricity remains rather expensive for the end-users. In addition, the system's limited load factor due to the small size of the village limits Sunlabob's revenues. The demand on site is lower than originally expected, which has required the company to lower its revenue projections. This was due to the lack of additional income generating activities that the company had planned on. After a period of two years they had counted on an average consumption of 1,5KWh/day/household, taking into account all village applications, but mainly because of the absence of the banking sector and of investment, these activities have been slower to develop.

Therefore, Sunlabob plans to expand its local distribution network and connect it with a nearby grid in order to attract the interest from the utility. Sunlabob has realized that small hybrid grids are an

attractive solution for the main grid since they include already-installed generation infrastructure and social organization. Thus, it makes economic sense for the national electricity provider to connect to this regional grid and to use the local providers as additional generation capacity. The utility will then take care of the village network and the bill collection (which will significantly reduce Sunlabob's costs) whereas the generating equipment remains operated by the private company.

This presents a triple advantage: the end-users will benefit from the subsidized social tariff that exist for grid users (US\$0.06 instead of US\$0.24), the utility will benefit from an additional and already operating power capacity, and Sunlabob will increase its revenues by using its full power capacity to sell electricity to the grid while reducing its costs. Thus, the project would switch from mainly private sector-based hybrid business model to a mainly utility-based hybrid model.

Sunlabob underscored that few problems had been experienced to date: a few users failed to pay their fees and a few were suspected of tampering their meters. The company has been addressing these issues through a series of meetings with the villagers and leaders.

This project demonstrates the different challenges facing a private entity looking to pursue a rural electrification project: High investment costs, low subsidies, obligation to collaborate with the utility, long-term collaboration, and relations with local players were all issues Sunlabob encountered. Most of all, this case study shows that long-term private sector involvement is possible if the right support schemes are set up, particularly in terms of regulatory flexibility.

Another example of a solar photovoltaic mini-grid with combination of government and community financing comes from India:

The objective of this project²⁴ was to implement a sustainable financing scheme based on a mix of subsidies and revenues: The central state covered the initial cost of the generating unit; state and local area development funds financed the distribution networks; and finally the revenue achieved through the sale of electricity covers the facilities' O&M costs.

WBREDA (West Bengal Renewable Energy Development Agency) owns all of the assets and has been implementing a fee-for-service model scheme, guaranteeing a reliable generation and supply of electricity to the consumers. The O&M is sub-contracted to a local enterprise that remains under supervision of the WBREDA. Management of the mini-grids is facilitated by village committees, and revenues are collected through the account of the co-operative society in the Rural Bank. Each consumer invested about US\$45 in connection fees and pays about US\$2.5per month for consuming 18-20 kWh.

Several partnerships have been set up, some between WBREDA and their PV supplier to set up and maintain the utility and between the state and the community. Thanks to this approach, the village committees have been successful in managing the entire scheme under the technical supervision of the state.

The two important successes coming out of this project were the implementation of a fee-for-service model that matches the users' ability to pay and is high enough to ensure ongoing O&M; and the effective use of various funding sources for setting up the utility.

Lessons learned:

- **Hybrid models are probably the most interesting, but the hardest to define because they combine many different approaches typically used in other models. Hybrid models can be quite diverse with changing ownership structures, O&M contracts, and other variables. They tend to be very site specific.**

24 "Solar photovoltaic minigrids in Sunderbans", Asia-Pacific Environmental Innovation Strategies (APEIS), Research on Innovative and Strategic Policy Options (RISPO), 2003.

5. Business, economic, and social factors

Successful financing and business models are essential for improving access to energy worldwide. Rural electrification has been the object of many development policies over the past 30 years. Most projects were planned over the short term and turned out as failures because of poor technical performance and poor suitability to user needs and local conditions. One of the important lessons emerging from this period was that donations or large capital cost subsidies without a sustainable business plan can destroy local renewable energy markets. A Shell executive notes that subsidies left the Indonesian market in disarray: “after only five years, most of the state-financed photovoltaic facilities are damaged. People don’t take care of things that they get for free.”²⁵

Over the past 10 years, two concepts have become central in the general development philosophy: sustainability and private sector participation. The huge investment needs in energy infrastructure, the failure of traditional development policies, and the inefficiency of the traditional utility-based power markets have pushed donor thinking towards the need to increase the participation of the private sector.

This shift towards market-based solutions has also paradoxically stressed the need for public authorities to accompany and incentivize the private sector. In the light of the lack of private investment, and given the inadequate infrastructure in developing countries, there is a continued need for well-conceived donor-funded programs. Where rural electrification took place without programs supporting economic infrastructure and the development of new skills, productive economic development did not follow, villages remained in poverty, and both the project and the ephemeral markets died. Economic benefits depend not just on the availability of energy, but also on other conditions favoring small business in rural areas, such as access to markets, finance, communications, education, and health care.

5.1. Operation and maintenance issues

Several problems exist when it comes to the financing of renewables and mini grids. One of the main ones is the question of long-term operation and maintenance (O&M). Generation and distribution equipment must be regularly maintained to operate efficiently and comply with the lifetime expected. A good rule of thumb is that O&M costs for a power delivery system should run between 1/8 and 1/30 of capital cost on an annual basis.²⁶ The lifetime of a mini-grid is considered to be around 20-30 years, but can be more than 50 years with proper maintenance.

Operation and maintenance therefore have to be planned carefully in any business development project and integrated into the project structure itself, as well as in the financing scheme, to be sure that the system will continue to run smoothly on a long-term basis. There is no project sustainability without a carefully established business plan integrating the question of the operation, maintenance and management (O&M&M) financing. Either the project has to generate sufficient cash flow to ensure its own sustainability, or subsidies have to be smartly targeted towards long-term O&M. The question of the financing of these costs is central as is the definition of the actor who will be responsible for this O&M.

Several options exist to share O&M management responsibilities (see section 5), though all are linked to the question of ownership and to the distribution of responsibilities between the different stakeholders involved in a project. Ownership is usually determined by the main source of investment in a project. However, when projects rely on government investment or grants from outside donor agencies, unless ownership rights, responsibilities, and risks are clearly established and transferred to local parties, the project is unlikely to maintain sustainable operation over an extended period of time. Confused ownership arrangements can swiftly lead to short-cuts on operating practices and long-term maintenance. This has been a recurring problem in Chinese rural electrification programs and it poses serious challenges to the sustainable operation of existing village power systems.²⁷

25 “Establishing renewable energy markets”, Hanisch C. Environ. Sci. Technol, 1999 in “Renewable energy markets in developing countries.” Eric Martinot, Akanksha Chaurey, Debra Lew, Jose Roberto Moreira and Njeri Wamukonya, Ann. Rev. Energy Environ. 2002.
26 “Technical and Economic Assessment of Off-grid, Mini-grid and Grid Electrification Technologies.” ESMAP Technical Paper 121/07(2007).
27 “China Village Power Project Development Guidebook: Getting Power to the People Who Need it Most,” SEPA/UNDP/GEF, Capacity Building for Rapid Commercialization of Renewable Energy.

Bergey Windpower, a partner of the Alliance for Rural Electrification, has participated in the “National Township Electrification Program” program built by the Chinese National Development and Reformation Commission (NDRC), initiated in 2002. The program was aiming at electrifying around 1,000 villages with renewables (including 268 small hydro and 721 solar and solar/wind village mini grids). In this framework, Bergey has built a hybrid PV/wind system which has been highly successful in reaching the people and satisfying local needs. The system is built around 21 small wind turbines of 10 KVA and a 90KVA PV array connecting 124 households with a maximum load of 235KW.

However, despite this success, a number of problems in the ownership and tariff structures have been identified putting the sustainability of the project clearly at risk. Renewable power systems for rural electrification in China are funded primarily by local governments, which consider their social impacts but not necessarily the importance of sustainable long-term operation. According to Bergey Windpower, this wrong prioritization and the unclear allocation of ownership are the first reasons why this program has been incapable of addressing O&M. The central and local governments covered all initial investments and the systems are theoretically possessed by the agencies; however, they are in fact owned and managed by the users. The fact that ownership rights have not been sufficiently transferred to local parties prevents them from taking over the responsibilities of their systems.

The second main problem, also linked to the lack of ownership transfer and involvement of the local consumers, is the tariff policy implemented. Each village was charged differently, but always insufficiently and in the case of this project, the tariff was as low as 0.8Yuan/kWh (~9 UScts 2002). According to Bergey at that time, the average cost per kWh for a solar standalone station was about RMB 6-7Yuan/kWh (~72 UScts) and RMB 2-3Yuan/KWh for wind (~24UScts), which shows the lack of sustainability of the system. Without continuous government support, a system’s operator could not gather enough money on electricity sales to support parts replacement, especially the battery.

This case study, unfortunately not an isolated example, exemplifies several key factors for a successful rural electrification program: the need for the program to be as much commercially oriented as possible; the need for a long-term structured project business plan; and the need to clearly establish the ownership rights. The resulting situation poses serious challenges to the sustainable operation of many existing village power systems. Another issue underlined by Bergey is the lack of follow-up projects based on this first phase despite the first initial successes. Thousands of renewable energy technicians have been trained but have never worked in the field because follow-up projects never materialized.

Therefore, one way to ensure that O&M are going to be taken care of is to have a clear definition of who is responsible for the systems and for monitoring ongoing maintenance.²⁸ Different schemes are possible (the maintenance will be borne by the end-users, a client selected for the purchasing power, an entrepreneurs/producers, or the utility itself), but clear ownership is central in the sustainability of a project.

Lessons learned:

- **O&M&M are the key components of a financially sustainable project. It has to be planned within the business plan from the beginning in order for the project to generate a cash flow sufficient to cover these costs. In order to do so, ownership rights and the role of each partner have to be very clear.**

5.2. Local private sector development and access to local financing

The question of project sustainability is closely linked to the issue of how to create a sustainable local renewable energy market. A successful business model covers the long-term operation and maintenance and relies on a strong local private sector with access to equipment and financing.

28 “How to Provide Cost-effective and Sustainable Rural Energy Services in Remote Areas of Developing,” Xavier Lemaire, webinar, www.leonardo-energy.org
<http://www.leonardo-energy.org/webinar-grid-regulation-how-rovide-cost-effective-and-sustainable-rural-energy-services-remote-area>

The availability of companies capable of providing at the local level renewable energy products, services, and replacement parts is critical to a program's sustainability. It has been estimated that tens of thousands of rural enterprises offering renewable energy-based products and services would be required to meet the needs of hundreds of millions of households.²⁹ The challenges are large: Entrepreneurs face high business costs in rural areas because of long travel distances, poor transportation infrastructure, low literacy rates, poor communications, and lack of trained personnel. In many countries, the development of large rural electrification programs is premature if they are not preceded by local business development programs focused on dealers. Before financing can be applied at the local level there must be demand for financing from consumers--and capable vendors to deliver equipment and services.³⁰

These issues of product availability, but also of training needs, leads to the question of technology transfer and the role of companies based in industrialized countries. Despite technical assistance financed by development cooperation agencies, technical and know-how transfer takes place primarily between private entities through licensing, joint ventures, or subsidiaries and those should be the target of public programs. A good option to spur these transfers is to link as a success criterion in international call for tenders the implementation of a project with actions for the local renewable energy market (i.e. subcontracting local firms, training). This would allow that any project realized by an international provider has spill over effects on the development of the local market.

Finally, a well-organized and influential private sector can be an interesting driving force for public change. In Mauritius, the involvement of the private-sector sugar industry, which advocated for continued support for the cogeneration program, was a key factor that led to the success of the program.³¹ In this context, market facilitation organizations or industry associations can play an important role and should be part of any large market-development program.

Sustainable rural electrification programs also need to develop local financing opportunities. Rural energy enterprises in developing countries are often seen as high-risk, low-margin businesses with high transaction costs. Commercial banks and financial intermediaries who are key project decision makers therefore have to be educated as well as encouraged to look at these markets. They must be familiar with the technologies and they must consider the purchase contracts secure enough to guarantee that power developers receive sufficient revenues and can repay loans. Most village-scale mini-grids are driven by government or donor programs, but there are a few cases that demonstrate the decisive role that a local financing sector can play in developing local markets. In Southeast Asia, for instance, rural entrepreneurs have started to build and run small mini-grid by borrowing from local agricultural banks; the loans are usually repaid after just a few years of revenues from electricity sales.³²

Financing programs for renewable energy systems have to address three different levels to have a deep and sustainable effect in rural communities: end-user finance, which will allow consumers to connect to a mini-grid and acquire electric appliances; business finance for small enterprises that will deliver or operate an energy system; and project finance for the capital investment. Therefore, financing programs need to rely on institutional capacities available locally, and must be able to work closely with these local players at the different stages of project development.

Such capacities include rural banking networks, microfinance organizations, agricultural cooperatives, or even electric utilities.³³ Renewables, wherever they are implemented, need long-term funding, which will require greater flexibility from financial institutions. Other options can also include a support to local financial intermediaries and instruments such as guarantees or other financial risk mitigation instruments.

29 "Renewable energy markets in developing countries." Eric Martinot, Akanksha Chaurey, Debra Lew, Jose Roberto Moreira and Njeri Wamukonya, op cit.

30 "Financing Mechanisms and Public/Private Risk Sharing Instruments for Financing Small Scale Renewable Energy Equipment and Projects." UNDP, GEF 2007.

31 Ibid

32 "Renewable energy markets in developing countries." Eric Martinot, Akanksha Chaurey, Debra Lew, Jose Roberto Moreira and Njeri Wamukonya, op. cit.

33 Despite their high visibility worldwide, MFI remain quite absent from many developing countries, especially in Sub-Saharan Africa. Out of the 20-30 MFIs worldwide that offer specialized energy loans, only 5-8 of these have a presence in SSA. "Session 13: User Financing via Microfinance Institutions (MFI) and Utility Bills." UNIDO, REEEP, 2008.

Lessons learned:

- **Successful rural electrification programs have to rely on vast networks of local companies (for products availability, trainings, O&M, spare parts) and financial intermediaries (access to finance at all project levels).**
- **This can be addressed in different ways: support technology transfer and company agreements, link call for tenders with criteria of subcontracting or alliance with local companies, provide technical and business trainings to local SMEs and support business organizations.**
- **For the banking sector, capacity building as well as financial instrument such as guarantees and other financial risk mitigation instruments are important.**

5.3. Information, marketing, education and capacity building

The issue of education and information is not limited to financing and should be more widely addressed. There are still many misconceptions about renewables based on project experience during the 1980s and 1990s, and most people are not aware of the technological improvements and recent market price developments. This education is important for end-users, business people, and officials in government agencies.³⁴

If these campaigns of information are very important to foster acceptability within the local population, they are probably even more in the business world to push for local projects and initiatives. For instance, within the framework of the National Power Corporation's Small Power Utility Group (NPC SPUG) in the Philippines, the International Finance Corporation (IFC), acting as program promoter, did strong prior education work with local power officials and business leaders to bring them on board with the project goals. Another part of their work was to convince private sector players that their energy projects could be bankable and attractive. For example, through countless "B to B" meetings, they presented practical and achievable solutions that could improve the energy off-taker's performance and growth prospects, once the power infrastructure would be installed. The involvement from the local private sector in the program shows that they succeeded.

In general, publicity and marketing campaigns around call for tenders are also weak in developing countries. Yet, they are often presented as a main reason for the success of some programs as the strong publicity increases the competition, which consequently minimizes the requirements for incentive payments, drives innovation and brings prices down (see Case study Senegal, section 5.4.1.).

The issues of training, capacity building, and embedding into local communities have also become central in modern rural electrification to ensure project sustainability. They are tightly linked with key questions on ownership, financing, and other factors, and have to be addressed right from the inception of the project. For instance, it is hard to avoid the question of local involvement when one talks about a business model based on a community.

Other sections of this study are detailing the importance of developing training and capacity building at every stage of project development for government staff, financial sector representatives, potential service providers, and consumers. Government staffs require training at a broader level, from basic technical aspects to electrification planning. Small private companies need instruction in business development, financial management, and project procedures. Community-based operators need basic training in equipment operation and business. Consumers require guidance in system selection and operation and choosing the service level best suited to their needs.

At the village level, local training and the involvement of the local population are very closely linked. In every type of project, regardless of the model used, it is critical to factor in education and training of end-users. Very early on, in the assessment phase, some efforts must be made to maximize community awareness, involvement, and support, which are vital to project success. From project inception, target communities must be reached via promotional programs and regular meetings with community leaders.

Most people in rural villages are unaccustomed with the range of uses electricity can serve. This can limit the benefits that potential consumers see for themselves. Therefore, the technical education of consumers to help them to make the best out of their systems and to ensure the project sustainability is fundamental. The active participation of end-users in this educational program on operation and maintenance has to be pushed since

34 "Renewable Energies for Africa: Potential, Markets and Strategies" REN21, 2010.

these activities are very complex to them. It is also important to ensure that the consumers are aware of their obligations in terms of payment and maintenance and of the repercussions for failing to live up to them. One mechanism for achieving this is to have each consumer sign an agreement when they apply for the service. Under some circumstances, utilities may require a security deposit from consumers before providing electric service, an amount that is returned to the consumer if he or she should terminate service.

An interesting experience underlining the need for consumer education happened in Lao PDR in a mini-grid set up by the Fraunhofer ISE, a research institute from Germany and a member of the Alliance. After the implementation of the project, several unexpected technical problems occurred in the mini-grid and the batteries were running down abnormally quickly. After checking the system which was functioning well, the O&M team realized that the villagers, encouraged by the success of the project, had purchased warming blankets, an unanticipated gadget in rural areas of Laos, and were using them regularly. This little anecdote underlines three things. First of all, it is important while designing a system to size it up slightly to leave room for new and unanticipated applications. Secondly, it is also important to size tariffs correctly in order to limit consumption and overuse of the system. Finally, it is fundamental to describe very clearly to the villagers, and especially to the village committee and to the people responsible for the O&M, the possibilities and limitations of their system. Consumer education and demand management policies are central to the sustainable operation of an off-grid system.

Failing to respect the payment methodology can jeopardize the sustainable operation of a system, regardless of the model used. Here, education must go along with sanctions. Collection can prove difficult because some consumers may want some favors (especially in a community-based organization) or may simply be unable to pay. To facilitate this task, all consumers must be aware of the fact that the operator is responsible for ensuring that all bills are collected and that he or she would be held personally responsible for any shortfall in the collection. Moreover, it is important that all consumers are aware of the consequences of non payment, including the possible impact on the long-term operation of the plant. It must be made clear that any consumer not paying will be disconnected. The policy concerning disconnection from the mini-grid must be clearly defined and well publicized, but above all must be enforced, or otherwise it might contribute to growing problems.

Another option for involving the end-users is through an appropriate use of connection fees. In most rural electrification projects, connection fees are necessary to recover part of the upfront connection costs to cover meters, poles, and other equipment. However, they are also often used to ensure a real commitment by the user to the rural electricity service and/or to prevent the users from creating excessive demands on the system.

In general, financial or other contributions from the end-users are a technique often used to ensure and increase the sense of project ownership that is critical to the sustainable operation of a system. Communities sometimes can pay up to 10-20% of the capital investment of renewable energy mini-grid systems upfront in the form of labor, materials, and cash contributions.

The government of Ghana decided to encourage the financial and in-kind participation of the end-users in rural electrification projects. In order to do so, it set up a self-help electrification program to encourage community development initiatives. Under the self-help scheme, communities can move to the "front of the queue" for grid connection and for rural electrification projects if they can supply a portion of the cost of distribution equipment and are able to provide labor for the installation of distribution poles.

These types of education and involvement schemes typically are adopted within the framework of every model. However, most of the local educational schemes are specifically targeted towards community-based models, which need a higher degree of self-organization and involvement from the rural population.

For instance, the creation of a village committee charged with handling all issues related to the energy system is a technique often used to give a sense of responsibility to the rural population. It has a critical role in terms of operation and management (see Case study TTA, Section 4.1), as well as of regulation and dispute adjudication.

This type of committee, usually based on pre-existing social structures, must be involved right from the project inception. It can be a good policy to involve the village representatives in the project negotiations to increase the feeling of ownership among committee members. This may push village leaders to have a closer look on the project developers, and ensure that they comply with the terms and conditions of the contract. This is quite different from relying on a long-distance regulator with no direct control on the operator. The village committee also can have a role to play in monitoring compliance with quality-of-service standards. Finally, village governments reduce the opportunity for corruption since the overriding incentive for a village involved in a project is to get results. This kind of social embedding is very successful and even unavoidable in community based mini-grids. In general, development organizations push for this type of self-organization social structure. Foreexample, in Smau Khney, Cambodia, the village mini-grid power supply agreement contract required that the private operator provides the Commune Electrification Committee with an annual functioning budget. This solution gives responsibilities to the operator and the village committee by providing the latter with a budget which also symbolizes its importance.³⁵

Other goals of the village electricity organization, in the community-based model, are to operate and maintain the system, to collect fees, and to manage these funds to finance ongoing costs of the system and replacement of components. An account with a local bank should be created to ensure that revenues generated from the operation of the mini-grid are properly accounted for and earmarked for the intended purposes.

Finally, training at the local level concerns the personnel responsible for the operation and maintenance of the power plant and mini-grid, as these are the people who play a crucial role in ensuring the reliability and sustainability of the system. This is especially important for community-based organizations, but it is also vital for utility and private sector-based models, which usually have one person on site to do the daily maintenance work and collect the payments.

Community members interested in these tasks should be involved from the project development and implementation. In addition to receiving training during project development and construction, training should extend over the long term to be effective. For instance, the implementing organization should periodically return to the community monitor the project, evaluate the quality of the service, review the maintenance records etc.

Solar Energy for Village Electrification in China, NAPS Systems Oy, 2003 :³⁶

This PV mini-grid energy system was funded by the Finnish government and installed by NAPS, a Finnish company, in Qinghai Shenge village, China. The project partners included the local Qinghai New Energy Research Institute (QNERI, in charge of the feasibility study and co-operation with the local institutions), NAPS, and the Finnish Ministry of Trade and Industry.

NAPS insisted on the importance of evaluating the energy needs of the villagers as well as their priorities prior to any system design. The key to local acceptance of this project was that the villagers were allowed to define for themselves the usage of the power they wanted. In addition, the villagers built a cabin and supplied building materials, which reduced project costs and increased local involvement. O&M is monitored daily by a couple in the village who was recruited for this role, but QNERI also can send a technician to the village to address more complicated technical problems. Capacity building included a training session for local installers and for end-users in the village, which was carried out at the same time as the installation of the systems. A QNERI team also attended a training session on solar energy technologies in Finland.

However, NAPS itself claims that there is a need for re-training and that the QNERI should organize basic training. The original training sessions should include plans for re-training and ongoing training of the local users. They also insisted on the attention that should be given to packaging and transportability of the equipment and on the components chosen since local availability of spare parts can be unclear.

35 "Electrification and Regulation: Principles and a Model Law." World Bank, 2006.

36 IEA PVPS TASK 9.

Finally, in an operator-based model, the revenues of the person on site are often indexed, or rely partly on the level of fees that he or she collects. This strategy encourages both the collection of fees, as well as good system maintenance (see case study Sunlabob, Section 4.4). In any model it is important to ensure that the person who exerts this task is rightly paid for the work performed (e.g., their salaries have to be included in the fee paid by the end-users).

Lessons learned:	
•	Education, training, information about the benefits of access to energy and of renewables are necessary prior to any project. Strong and targeted publicity campaigns explaining rural electrification programs will increase positive impacts.
•	Capacity building on technical, business, financing, and institutional aspects of project and program development is necessary at every point of the project chain and must include every stakeholder. This is unavoidable to maximize the positive effect of rural electrification and to ensure sustainability.
•	At the village level, detailed technical training for end-users must cover both electricity uses and limits. The personnel responsible for O&M should also be trained right from the project implementation, with follow-up training over the long term.
•	Involvement of all the villages' stakeholders within the project is fundamental: The village committee (created around existing local authority structures) should be involved from the inception regardless of the model (assess the need, monitor the project, organize the communities, develop added value etc.).
•	Involvement can take different forms: participation in the initial investment, connection fee, monthly payment etc. The disconnection policy has to be very clear and enforced. Finally, the involvement of the local personnel responsible of the O&M can be increased by tying salaries with performances.

5.4. Business enabling environment and regulations

Attracting the private sector into power generation on a sustainable basis in developing countries has been a continuous challenge for governments and international organizations. Even though this mission has clearly failed in most developing countries there are a few lessons to be gained out of the massive project experience acquired throughout the world. The key parameter for attracting the private sector is the profitability of the project. A public actor leading a program can act on several factors to attract private companies: productive use and market size are the first one.

5.4.1. Acting on the market itself: productive use and market aggregation

A first solution is to design rural electrification projects around already existing business applications — or those close to existing. The economic viability of mini-grids often depends on the presence of an industry because households do not usually provide an adequate revenue base to pay for mini-grid investments³⁷ Many off-grid communities have activities that require energy or have a strong potential for initiating such activities, but are constrained by the lack of a stable and reasonably priced energy supply.³⁸ Therefore, off-grid project designers should take advantage of opportunities that will significantly increase the prospects for long-term project sustainability through the direct generation of revenues. For instance, businesses fed by small diesel generators that are direct competitors of renewables mini-grids, are a good target for project developers. These types of businesses indicate significant potential for utilization and the willingness to pay for electricity service.

A more global approach, but following the same logic, is to link a rural electrification project with a strong business development approach. This means that the project designers identify prior to the project implementation the likely local participants for a micro business and assist them in developing business activities. If this approach succeeds, it also dramatically increases the chances for the project to be sustainable over time. Collaboration prior and during the project with local partners such as NGOs can be a good way to complement the outreach activities of the company.

37 "Renewable energy markets in developing countries". Eric Martinot, Akanksha Chaurey, Debra Lew, Jose Roberto Moreira and Njeri Wamukonya, Ann. Rev. Energy Environ. 2002.

38 "Operational Guidance for World Bank Group Staff: Designing Sustainable Off-Grid Rural Electrification Projects: Principles and Practic-es." November 2008.

Senegal has taken a very proactive attitude towards maximizing positive impacts from access to energy in rural areas. Two different approaches have been tried out to increase revenue generation.³⁹ The systematic approach analyzes prior to the project all the different aspects of local economic life that energy could improve, and tries to address the barriers that could limit the project's impact. This approach is systematic in the sense that it does a thorough review of all productive or social activities taking place in a designated area and sees how electricity would interact with these activities. After a review of the situation, project planners can formulate a targeted promotion campaign about what each local stakeholder would gain from access to electricity.

The pragmatic approach follows a tactic based on opportunities. This approach observes all ongoing or planned projects in other sectors in a specific area and sees how access to electricity could improve them and provide rapid revenues. It is pragmatic because it focuses on existing projects, where most of the preparatory work has already been done and investments planned, and observes the added value that electricity could bring to this project. This approach relies on multi-sector energy investment projects where all the stakeholders collaborate.

With the large support of the World Bank, the Senegalese authorities adopted both approaches for different cases.

Regarding the systematic approach, a team of consultants representing a large scope of rural activities identified the potential gains of productivity linked with access to energy in the different productive sectors providing a sense of processes that should have a priority for electricity investment. The main result of this work was a supporting tool delivered to the ASER (Senegalese Agency for Rural Electrification) for its "Program to Maximize the Impact of Rural Electrification" which focuses on increasing productivity of rural areas, as well as on creating and valorizing new economic activities by use of electricity. This program also aimed at avoiding duplicating other stakeholders' initiatives and at correctly sizing the levels of electricity use. Therefore, after this preliminary work, the ASER used the information generated to feed into its RE impact maximization program with information campaigns on the advantages of electricity for productivity gains and the development of economic activities. ASER worked to ensure the availability, marketing and commercialization of relevant and viable electric equipment and materials.

For the pragmatic option, the objective was to create some MEC (Multisector Energy Investment Projects) around local activities with high development potential, such as the provision of electricity to dairy and cattle feed. Several MEC have been chosen out of the most promising activities and imposed within the concession bid. The company winning the bid had to fund, provide and operate the "before meter" electrical equipments of the imposed MEC as part of the rural electrification concession. Whereas the sector anchor program, who is the leader of the activity, was responsible for the project and provided the financing for the equipment situated after the meter, all the civil construction work, and the sizing costs. The concessionaire funded the electric equipment. This integration of productive uses within the concession themselves was rather well accepted by the bidders, who could to apply for an additional subvention to the FER (Rural Electrification Fund) to cover part of the MEC investment.

The complete methodology used by the program promoters in Senegal is explained in the excellent ESMAP Paper: "Maximizing the Productive Uses of Electricity to Increase the Impact of Rural Electrification Programs." ESMAP, 2008

39 Full case Senegal study at "Maximizing the Productive Uses of Electricity to Increase the Impact of Rural Electrification Programs." ESMAP, 2008. pp.27-33 for systematic approach, pp.43-48 for pragmatic approach.

Institutional or community applications are another important market segment for mini-grids. Publicly funded institutional applications can be added to a rural electrification package offered for bidding along with households or other users that may not be as attractive financially to project developers and investors. The relatively large size of institutional installations and their assured nature greatly increase the package's attractiveness to private-sector bidders.

The World Bank and its partners have already used an approach integrating institutional applications into rural electrification "packages." For instance, the Philippines Rural Power Project has embedded this type of initiative in the Sustainable Solar Market Package (SSMP). Communities were clustered into commercially viable business packages for PV installations. Each cluster group consisted of both households and public centers; PV installations and maintenance in public centers are paid for by donors, while a partial grant makes household systems affordable. The contractor winning the international bid is then obliged to provide services to a minimum percent of households in the area. Following the achievements of the Philippines' program, the SSMP was reproduced in Tanzania in 2008 with success.

Another approach aimed at increasing the attractiveness of rural electrification focused on concentrating energy loads or bundling projects together in attractive packages. If their relatively small size makes many rural renewable energy projects generally unattractive for financing or developed on an individual basis, the overall market potential is very large and can become interesting to more stakeholders. Therefore, strategies to aggregate the market for project marketing, development, and financing purposes are relevant and of interest to all stakeholders from project developers to investors by allowing economies of scales, while reducing administrative and operating costs.

This type of bundling process is already used or envisaged for projects related to climate change in order to increase access to climate finance for small-sized renewable energy projects in developing countries. The same kind of procedure, simplified and standardized, could greatly increase interest from private investors and developers.

Territorial concessions are the most popular type of bundling project throughout the world. The holder of a concession enjoys some beneficial terms (such as preferential market access or a direct subsidy) for providing power services to rural communities living within a defined geographical area. Mini-grids are a technology perfectly adapted to this approach since they are natural monopolies. Therefore, from a regulatory point of view, it makes sense to require operators to follow specific rules (i.e., regarding tariffs and dispute settlement) and to grant concession or licenses, with the notable exception of community-owned and operated systems. While concessions are an instrument often promoted by development organizations and agencies and which have had some successes, for instance in Chile and Argentina with SHS and mini-grids programs, some actors also contest their merits.

Senegal has used rural concessions within its electrification program to attract private companies. The country has been divided in areas designed to be compact yet large enough to be commercially viable and attractive. The bidding process was designed to be results oriented. The firm that offers to provide the maximum number of connections within the first three years, for a preset subsidy amount, was awarded the concession. To overcome the barrier of high up-front connection costs, to leverage private financial resources and to ensure the quality of the connections, a significant part of the subsidy was disbursed only after the connections were made and verified (connection-based subsidies). The business plan model, developed during the concession design phase, demonstrated that the monthly user payments will cover the O&M&M costs as well as at least 20 percent of initial investment cost, assuming a 20 percent rate of return. In addition to the core investment subsidy allocated to the concession area, an additional subsidy financed under a grant received from the Global Environment Facility (GEF) was targeting exclusively renewable was also made available to level the playing field for renewables. However, the selection criteria remained the maximum number of connections independently of whether or not bidders would claim the GEF subsidy and install renewable.

The utility ONE from Morocco won the final bid, but the competition led to a dramatic increase in the number of connections compared to what was initially expected. The winning bid proposed to more than double the minimum 8,500 connections set in the tender documents with a target of 21,800 connections. The winner also brought US\$9.6 million of private financing (equity and commercial loans) which was far higher than the 20 percent expected. In fact, the average cost per connection is estimated at US\$725 with the subsidy per connection representing only 40 percent of total cost. It has to be noted that, if most of the connection will be achieved through the extension of the grid, around one-fourth of all connections will use renewables and especially PV systems, with the GEF subsidy corresponding to only US\$1.03 /Watt peak. The choice of PV was only based on economic considerations, namely the distance to the national grid.

These good results demonstrate that the combination of international competitive bidding with territorial concession and output-based aid can leverage significant amount of private resources and deliver good results. Overall, the project was considered a real success.

However, several stakeholders have underlined on several occasions the failures of such a system. KfW for instance has been building much of its access to energy approach in Africa on the negative concession system (lowest price for a preset number of connections), including projects in Mali and Senegal. According to their project managers, the concession model is a very long and complex process with high transaction costs. If they have succeeded in involving companies from the African private sector there was a general lack of interest from the bigger and foreign energy companies, despite interesting conditions.

A company member of ARE, which has been very involved in the design of these large-scale concession schemes, also pointed to the length of the process in Senegal (10 years of planning studies to reduce the number of concessions from 18 to 11 for reasons of economic viability issue).

Lessons learned:

- **In order for a project to attract a private actor and/or generate sufficient cash flow for O&M and profitability, several options exist:**
- **Projects can be built around existing business applications or public institutions in order to increase critical mass, potential profits, and local involvement. An alternative would be to support the development of a local private sector as part of the project to increase the positive impacts on the community and generate the needed revenues.**
- **Concentrating energy loads or bundling projects together in attractive packages is another means of increasing market size and the attractiveness of rural electrification projects. Territorial concessions are a good strategy but they need to be simplified to diminish the costs and the time involved and to attract the private sector.**

5.4.2. Acting on the project revenues: tariffs and subsidies

Tariffs and subsidies:

The determination of the tariff is a central question for the sustainability of a project especially when it comes to O&M. Along with the questions of subsidies, it also influences the profitability of a project and therefore plays a role in the business model that will be chosen.

A basic rule generally accepted in rural electrification planning is that, regardless of the scheme chosen, a tariff should at least cover the running costs (O&M) to ensure the ongoing operation of a system throughout its lifetime. Cost-based tariffs are also essential to project developers when it comes to demonstrating the financial viability of a project. Moreover, tariff must also integrate replacement necessities (batteries) and should contribute to a "reserve" of funds that will be used for these punctual replacements. Last but not least, tariff structures must keep a balance between ensuring commercial viability (sustainability), and meeting rural consumers' ability and willingness to pay (affordability). To achieve these different criteria, the tariff should not be set as a matter of principle at the level of the national utility on the grounds of being "equitable"; neither should it be based on the consideration of the households' energy expenses (i.e. kerosene lamps, candles

etc.) before the project. The concept of affordability plays of course a crucial role but it can be balanced with subsidies. Tariffs must be flexible and tailor made.

“All our tariffs are social tariffs .”⁴⁰

Many African countries are charging electricity significantly below the costs. When they are trying to change this in order to cover the operating and maintenance costs, customers are opposing arguing that service is poor and utilities should not be rewarded with higher tariffs. In contrast, utility officials argue that service is poor because they have insufficient funds to replace needed parts and to perform basic maintenance.

Most rural electrification tariffs usually have two basic components, each with a different objective: connection fees and operation fees (which can be monthly or other). The connection fee is generally used to cover the costs of meters and poles and/or to recover part of the upfront investment costs. The added objectives of the connection fee are to test the real commitment and involvement of the users and to prevent them from creating excessive demands on system capacity (see “Information, marketing, education and capacity building”, Section 5.4.1.). In-kind participation (labor and materials) from the villagers is another approach often used by project developers to cover these costs and to increase local participation (see case study TTA and Sunlabob in Section 4.1 and 4.4). Some studies have found that the willingness to pay the connection fee is a good indicator for a sustained use of electricity and the payment of monthly tariffs.⁴¹

For the sake of project sustainability, two main types of tariffs are relevant:

1. **Break-even tariffs** are designed to ensure just enough revenues to cover its operating, maintenance, and replacement costs. They are more easily affordable by most customers, especially if a subsidy is used in order to reduce the investment or customer connection costs (this type of tariff is especially relevant for community-owned systems). Of course, these types of projects usually require that the overhead costs and initial investment costs are entirely or at least greatly covered by other financial means.
2. **Financially viable tariffs** are designed to allow for sufficient return on investment to attract private sector investors. The private sector participation may result in higher tariffs, or in higher subsidies to keep tariffs affordable, but also in more efficient operation. A financially viable tariff is designed to cover the costs of all system components.⁴²

Other possibilities proposed by some specialists are known as binominal tariffs. They start from the idea that the costs associated with energy generation from renewable sources are

essentially fixed independently of the actual consumption of energy (low operating expenses), whereas electricity generation from diesel gensets, for instance, has some fixed costs, but a significant amount of variable costs associated to the consumed energy. Following this principle, a fixed monthly fee may be a more appropriate tariff scheme for RE mini-grids, since it is more directly related to the cost structure of a RE power system and it provides the operator with reduced transaction costs and a clearer financial forecast.

In July 2003, the Remote Area Power Supply (RAPS) system started operations, providing 24-hour electricity services in a rural area of Peru called Padre Cocha. The system serves 240 consumers and public street lighting. It consists of two 14 kWp PV systems with a total capacity of 300 kWh/day including 240 storage batteries of 375 Ah; and a single diesel generator of 128 kW. The daily total average energy consumption is near 220 kWh, 30 percent of which is produced by PV and the rest by the diesel generator.

The total cost of the system is estimated at US\$577,000, but in the end of 2004 the organization that implemented the system reported an expenditure of US\$2 million in administration, promotion, studies and equipment acquisition mainly financed by a private donor IIZRO (International Lead and Zinc Research Organization), the Common Fund for Commodities, Sandia Nat Lab and the Loreto Regional Government. The Operation and Maintenance (O&M) costs, including purchase of fuel and provision for battery replacement, are US\$37,704 per year. Since the RAPS was commissioned, a local community organization has been responsible for the system’s administration, operation, and

40 “Session 11 Financing and Subsidies for Utilities”. UNIDO, REEEP, 2008.

41 “REToolkit: A Resource for Renewable Energy Development.” World Bank, 2008.

42 The project implementation price includes the systems itself, the training, and the installation costs. The price structure for electricity generally consists of: Capital cost, generation and distribution cost, if applicable fuel cost, annual operations, maintenance, management (both labor and materials), periodic equipment replacement, taxes and levies, profit for the operator and return on equity for investors.

commercial service. The local community fully participated in this institutional structure, however, its technical and management capacity is limited and the system was incapable of generating its own revenues to cover the O&M costs and continued to rely on the main initial investor.

Trama Tecno Ambiental (TTA) was charged with analyzing the financial and institutional processes of this installation, studying its replication potential and proposing solutions to increase the sustainability of this system. First of all, TTA addressed the question of tariffs as “the single most important factor” determining the long-term commercial viability of mini-grids. Since the RAPS system began operations, two different tariff schemes have been applied, but neither could provide sufficient income to cover the O&M costs under the current demand pattern:

- First, a flat charge of US\$6.38 per month was applied. This resulted in very high energy consumption per consumer and frequent complaints from small consumers who were not benefiting from energy. Moreover, the tariff was not covering the O&M costs.
- The fixed charge subsequently was reduced to US\$1.47 per month, with an additional energy charge of US\$0.20 per kWh. However, this type of regulated tariff appears quite inadequate for rural villages characterized by low consumption users and was still representing only 45% of the O&M costs.
- As a reference, the socioeconomic evaluation conducted prior to the project recommended a flat charge of US\$10 per month for contracts up to 15 kWh per month, plus an energy charge of US\$0.53 per kWh for additional monthly consumption above 15 kWh. But this tariff, above the willingness to pay of the end-users, was never applied by the operator.

TTA based its analysis on a regional study concluding that the users' willingness to pay was around US\$6 for the very low consumption users, and around US\$10 for the average consumption users. Based on these numbers but also given the costs structures (high transaction costs) of the hybrid system and the local consumers situation (large number of “very low” consumption contracts), they proposed a different tariff schemes with a flat fee of US\$8 for contracts up to 8, 5 kWh/month to which a charge of US\$0, 35/kWh should be added for the contracts above 8, 5 kWh/month. In the case of Padre Cocha, they calculated that this tariff would cover all O&M&M and replacement costs. Beside the tariff issue, they also recommended to reduce distribution losses, to cut administrative costs and to increase promotion and publicity actions to enlarge the consumer base. Finally, it is interesting to note that the consultants concluded: “diesel-gensets are neither affordable nor sustainable, even with 100 percent capital subsidies. On the other hand, diesel-PV-hybrid systems become more attractive, since they require lower tariffs and are less exposed to fuel price volatility. For a village similar to the load demand in Padre Cocha, a properly designed diesel-PV-hybrid system can offer an affordable tariff”⁴³ with a limited support on the capital subsidy (50-80%).

Some interesting lessons can be drawn from this analysis of a hybrid's power system tariff policy: first of all tariffs need to recover O&M&M to be viable. Then, it is recommended to design a tariff that reflect the system's costs structure: a fixed monthly fee reflecting fixed O&M costs, a small variable charge to reflect fuel costs, and a levelized capital cost charge to partially reflect investment costs. This type tariff has the other advantage to provide the operators with reduced transaction costs and a clearer financial forecast.

Mini-grid systems can also follow a **graded tariff regime** (low tariffs for the first kilowatt-hours and higher tariffs for heavier consumption), just as some grid systems do. This allows the tariffs to be set in better proportion to the customer's ability to pay and follows the assumption of a diminishing marginal utility of electricity. This also allows the setting up of different subsidy schemes better adapted to the consumption of the end-users.

Complementary to the tariff setting, **different combinations of subsidies** can be developed to help make the connection or the operation costs affordable to end-users on one side, and/or focus on the investment costs of the system on the other side. Given the limited resources to fund rural electrification it is essential that subsidies are spent efficiently to support poor rural areas in accessing modern energy services but also to increase the commercial potential of rural projects and therefore to leverage private investments.⁴⁴

The most common subsidy schemes are:

⁴³“Solar-diesel Hybrid Options for the Peruvian Amazon, Lessons Learned from Padre Cocha”, ESMAP Technical Paper, 2007.

⁴⁴ According to the World Bank efficient subsidies must be transparent; target people in most need of support; easy to administer; linked to results (i.e., focus on expanding access); strong cost-minimization incentives (i.e., retain the commercial orientation to reduce costs even though subsidies are being provided); and ensure good governance. “REToolkit: A Resource for Renewable Energy Development.” World Bank, 2008.

- **One-off subsidies or capital subsidies** target the overall initial investment or at least part of it. Allied with a smartly designed tariff scheme that covers the O&M&M costs they can be sufficient to make a mini-grid project commercially viable. Following this principle of tariffs which recover the running costs and of which down initial investment costs, RE mini-grids can become really attractive since they require lower tariffs compared to diesel generators, and are less exposed to fuel price volatility.
- **Operational subsidies**, cover the operation of the system, but not the production. They are needed where there is a gap between affordability and cost recovery and consequently, operators are left in a perpetual dependence upon public money without incentive to produce more or more efficiently. The problems arise if no strategy to phase out these subsidies or to increase the community's revenue has been launched. Furthermore, there is no incentive to extend connections since returns on investment may not cover costs.
- **Output-Based Aid (OBA)** consists of a subsidy planned directly in exchange for a service to encourage its occurrence. These subsidies can be established either with a connection-based or production-based approach. The latter subsidy is intended to decline over time as the service provider improves efficiency and as end-user revenues increase. OBA subsidies are becoming more popular since they specifically target project sustainability (see case study Senegal and Philippines Section 5.4.1. and 4.2.). They are also the support schemes for renewable energy in Europe (feed-in tariffs), where they have enabled the large development of industry. However, this massive success has been mainly possible because banks were ready to lend investment capital only based on stable and credible off take agreements.
- **Lifeline rates** (subsidizing energy use for the poorest consumers) and cross-subsidies (where richer consumers help subsidize poorer consumers, and rural electricity use is subsidized by urban consumers) can also be successful.

Many rural electrification programs try to combine different types of subsidies to make them coherent at the national level. For instance, TANESCO, Tanzania's state-owned utility, operates 11 isolated rural grids and provides electricity to the rural population using a social tariff for consumption below 50 kWh/month. The cost of generation on these isolated grids is considerably higher than the prices charged to the grid customers and TANESCO subsidizes these isolated grids by charging higher prices to industrial customers. The fact that Tanzania's national electricity law permits non-uniform electricity tariffs can also be seen as a potential support scheme capable of attracting off-grid operators in rural areas seeking local tariffs higher than the national tariffs (and more subsidized).

While capital subsidies (with good tariff schemes) remain the prevailing support mechanism there are ever more voices advocating for OBA schemes.⁴⁵ The theory is that subsidized investments and business development should lead to lower costs, through enhanced learning curves and economies of scale, to a point where subsidies become unnecessary. These subsidies integrate a phasing-out process and are supposed to be self eliminating. Smart subsidies also imply payments based on performance, rather than on capital investment.

In Sri Lanka, a supporting approach is being taken based on economical performance and commercial viability. This approach includes support to the private sector, phasing out OBA grants, and collaboration with the financing sector. The main strength of the Energy Services Delivery project (ESD, 1998-2002) and of the Sri Lanka Renewable Energy for Rural Economic Development (RERED, 2002) project is to be centred on the commercial provision and utilization of renewable energy resources with a focus on the economic development of rural areas as well as on an excellent access to credit program. This program is designed to promote private sector and community-based initiatives for the provision of electricity services through grid-connected mini hydro projects, off-grid village hydro schemes and solar photovoltaic electrification of rural homes.

It includes a phase-out strategy and aims at increasing affordability as well as commercial viability while retaining cost-minimization incentives. The scheme combines grants and debt finance with the idea that the "last dollar" should be borrowed on commercial terms. This provides a key incentive to minimize costs since the promoter borrows at relatively high rates. This medium to long-term funding was provided to private investors, non- governmental organizations (NGOs) and co-operatives for off-grid electrification infrastructure through village hydro, schemes and solar home systems and other renewable energy investments.

45 Such as ARE and the Joint Research Centre of the European Commission. "Renewable energy markets in developing countries." Eric Martinot, Akanksha Chaurey, Debra Lew, Jose Roberto Moreira and Njeri Wamukonya, Ann. Rev. Energy Environ. 2002.

The grants support the initial investment with disbursements linked to targeted outcomes/outputs (OBA). With the increasing commercialization of the industry, the co-financing grants are phased out for products that have reached commercialization, but remain for smaller systems that are not yet viable. This approach is possible thanks to a strong business development capacity-building program, including the creation of industry associations, and also benefits from a strong collaboration with the financing sector (see figure 10). The program has also left substantial autonomy to the project developers over the choice of the technology used as well as of the business structure chosen.

Figure 10. Flow of funds under the credit facility of the program, Sri Lanka⁴⁶

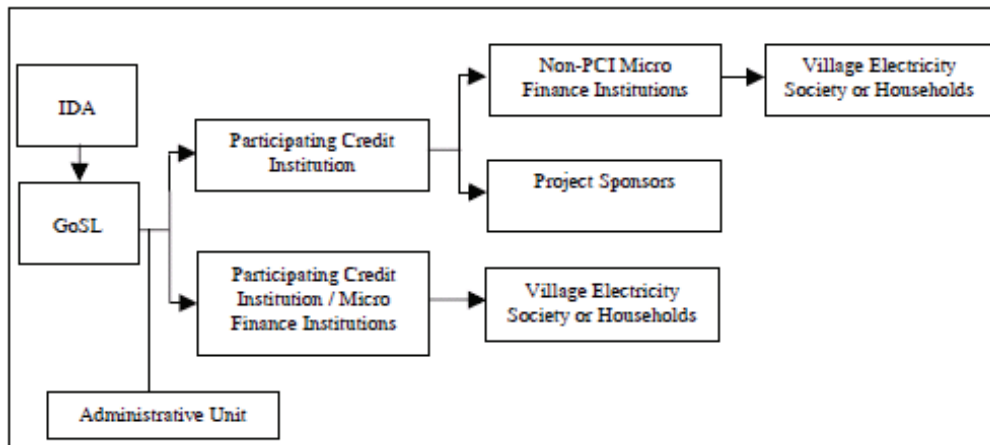

This program proved to be successful in offering access to finance to local entrepreneurs, in developing a local industry of PV and mini hydro, but most of all in increasing significantly access to energy in Sri Lankan rural areas. It resulted in a dramatic increase in the development of grid-connected and off-grid renewable energy projects, prepared and implemented by the private sector and village communities.

For instance, at completion, the ESD Project Credit Program had met or exceeded all targets: 31 MW of mini hydro capacity installed through 15 projects against a target of 21 MW; 20,953 solar home systems installed, with a total capacity of 985 kW, against a target of 15,000; 350 kW of capacity through 35 village hydro schemes serving 1,732 beneficiary households against a target of 250 kW through 20 schemes. The follow-on Renewable Energy for Rural Economic Development (RERED) Project builds on this success.

Besides a well built access to energy program based on a sound collaboration between the different economic sectors, an ambitious access to finance scheme and the development of local renewable energy industries, these projects also demonstrate that costs-competitive and profitable access to energy programs based on renewable energies are possible when they are well designed and integrate more particularly access to small scale finance and capacity building.

Besides subsidies, other more indirect support schemes exist. For example, investment and production tax credits also have been employed in developing countries. Reducing import duties can also have a dramatic influence on price and costs. In fact, the relatively high cost of renewable technologies in Africa, for instance, can partly be attributed to high duties imposed on imported components, the high transaction costs in acquiring them, and the relatively low volume of purchases. Cases have been reported of solar PV systems being three times more expensive in Ghana than in Bangladesh, and small hydro being twice as expensive in African countries as in Sri Lanka because of import duties.⁴⁷ Additional support can also involve technical assistance, site surveys (i.e. wind maps), feasibility studies, market assessments, and capacity-building provided to the investors or project developers during the project development phase.

46 Sri Lanka Renewable Energy Program, Renewable Energy Project Toolkit Case Study.

47 "Renewable Energies for Africa: Potential, Markets and Strategies." REN 21, 2010.

Many instruments have been developed and tried out to offer the best support scheme to allow a project to take off and to be sustainable on a long-term basis (see figure 11).

Figure 11: “Instruments to support renewable energies and rural electrification from classic assistance program to new instruments.”⁴⁸

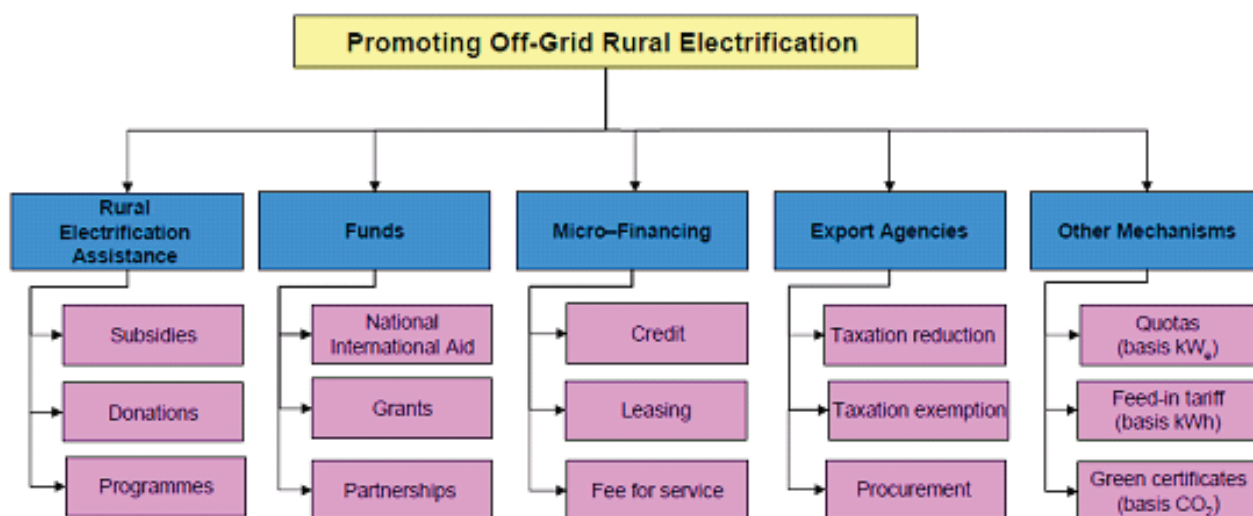

Lessons learned:

- Rural electrification tariffs must at least cover the running (O&M) and replacement costs (break-even tariff), even though the opportunity for profit is key to attract private operators (financially viable tariffs). Tariffs must maintain the balance between commercial viability and consumers' ability and willingness to pay. Connection fees play a very specific role in tariff structure, as does tariff collection.
- Smart combinations of subsidies, along with good tariff structures, are key to attract operators and ensure project sustainability. They can support the investment, the connection, the operation, and the output. Investment subsidies are a good solution if they go along with a good tariff structure; whereas OBA schemes if adequately planned are powerful instruments to leverage private investments and ensure O&M.
- There are additional measures which lend themselves to be offered to project developers: tax credits; low import duties; site surveys; market studies; and capacity-building.

Tariff collection mechanisms

An important task to ensure the sustainable operation of a mini-grid is payment collection. First of all, the payment method has to be clearly defined, stated, and well publicized, regardless of the method itself, for all the end-users to be aware of the expectations. Clear records must be maintained by the person responsible and be available for review. The importance of paying the fees must also be clearly explained, with the possible consequences for individuals and the whole community for anyone who tampers with the meter or fails to pay up.

48 “Concepts for Hybrid PV Village Grids to Make their Operation a Local Business”. B. Ortiz, M. Vetter, S. Götz, G. Bopp, Fraunhofer ISE, 2007.

There are two broad categories of tariff schemes, each with different types of collection mechanisms:

1. **Energy-based tariffs** are calculated according to quantity of electricity consumed over each billing period. To enforce this type of tariff, energy meters are commonly used. Energy meters present several advantages mostly because they allow the consumers to have an accurate record of consumption and are therefore useful to incentivize energy conservation and efficiency measures. However, they also present some drawbacks (mainly price), which can have a real influence on the global costs of an off-grid system or on the connection fees. Moreover, they are not necessarily reliable and they might be hard to read for uneducated rural people. They also require the operator (or the regulator) to organize regular visits on site to control the meters. Even if it can also be done remotely, or if it is possible to have local delegate to take care of this mission, this might also have an influence on the running costs. In addition, meters alone do not limit peak demand of each consumer; neither do they prevent system overloads. If meters are used without additional load-limiting components they have limited interest for decentralized systems.

Consequently, prepayment meters (or electricity dispensers, see Case study TTA, Section 4.1.) present a good alternative to normal meters. With this system, the consumers need to purchase in advance units of electricity from the operator or electricity supplier and when they run out of credits their supply shuts down. Prepayment meters obviate the problem of reading, billing, and collecting altogether. They also help avoid overdue payments and make budgeting easier for the consumer. Finally, these meters are useful in setting up energy conservation plans. The main disadvantage is the cost of the meter, which can be significant, and the need for an operator to have a well-organized local sales and support services. Currently the cost of the meters is high as their production volume is small (e.g. TTA is designing and building specific Energy Dispensers for each project, explaining the high costs of this instrument).

2. The second main type of tariffs is based on **expected power consumption**. In this case, the key factor is the maximum amount of power used. The power available to the consumer is predetermined (based on existing or desired appliances and the regularity of their use) and a payment is made on the basis of this level (usually several categories of users and several power ranges are foreseen). This approach has the clear disadvantage that abuse is difficult to contain; however, some options exist to enforce compliance. It is possible to electrically limit the current entering into the home. This allows for setting a limit on peak demand, preventing system overloading and ensuring that all consumers have an access to some electricity (all these advantages are especially important when it comes to mini-grid systems). Moreover, reliable load limiters are much cheaper than meters and prepayment meters.

Payment is also made easier for both the collector and the consumer, as the amount to be paid on a regular basis is known in advance. Payments made in advance also can ease the cash flow for the operator. However, load limiters have the disadvantage of leaving room for consumer fraud and theft. Tampering with load limiters is not rare in developing countries and it can endanger the whole system since this type of fraud is hard to control. Therefore, these systems oblige the operator to work harder to educate the consumer on the technical aspects of the system and on the electric appliances they can use. Another considerable disadvantage of load limiter and capacity-based tariffs is that the electricity available for the consumer is limited—this is a real drawback, as one goal of mini-grids is to deliver large amount of power to local businesses. Thus, load limiters should not be used with larger consumers, as these customers can carry the cost of a meter.

Both techniques have associated costs due to the control measures set up and the instruments installed. However, they are unavoidable to limit consumption, ensure revenue collection and hence the O&M but also to guarantee the safe operation of the system. The technique can also evolve according to the clients to be served and the revenues generated. It is possible to have the two different systems applied in the same village with poor households being served with a load limiter and the small enterprise with a meter.

When the amount of electricity purchased and consumed is not fixed and paid in advance, another issue regarding payment collection is how often end-users should pay for electricity services. The payment schedule needs to be well established and publicized and it also depends of the kind of business model that has been set up. For instance, if a private company is in charge of the system's O&M, a monthly payment will usually be requested, since the scheme is more suited to the provision of a service as well as to the necessities linked with private sector-driven O&M. In contrast, a community-based system will probably be more inclined to accept other payment cycles.

Monthly payments are common for urban consumers, but can be difficult to implement in rural areas where incomes vary seasonally based on agricultural sales. Making annual or semi-annual payments might therefore be more suitable, since they can be fixed on local harvest schedules.

A last type of payment sometimes found in rural areas of developing countries is the payment “in kind.” Payment usually involves marketable livestock or agricultural products, and the consumer has considerable flexibility. Therefore, this scheme is usually used with community-based organizations able to redistribute or market these commodities. Of course, it involves additional work for the persons responsible for the operation, maintenance and tariff collection since they in turn are required to transform these payments into cash.

Lessons learned:	
•	Payment methods have to be clearly defined and well publicized. Clear records must be maintained and available for review.
•	<p>Two main categories of tariff collection exist:</p> <ul style="list-style-type: none"> • Electricity-based, which is a function of the actual electricity consumed that works with meter and prepayment meters. It gives an accurate record of consumption; people can pay in advance for a limited dose of electricity (clear cash flow plan for the operator and consumption for the user), and makes energy conservation and efficiency measures easier to implement. The main disadvantage is the cost of the meters. • Power based, which is a function of the anticipated power use. It limits the current entering into the home through a load limiter and the people pay for a dose of power. It is cheaper; it limits peak demand, prevents system overloading and ensures access to electricity for all. However, it also limits power capacity for large user and requires more education.
•	Tariff can be collected monthly or with different occurrences (for instance in parallel with crops).
•	Payment can be in cash or in some cases “in kind.”

5.4.3. Acting on regulation: policies and contractual agreements

In addition to these schemes, regulation and frameworks conditions related to energy policies or contracts can play a significant role in the area of rural electrification business, especially with mini-grids and their complex set-up requirements. For instance, in the case of grid extension, mini-grids can easily feed into the main grid. This can be seen by a company either as an opportunity if the regulation is catering to feed-in solutions and the tariffs are commercially interesting or as a threat if it takes clients away from the off-grid operator. Another case to consider is the spontaneous development of independent operators.⁴⁹ It is not rare in developing countries to find small private entrepreneurs, cooperatives, or local government units operating mini-grid systems. These small entrepreneurs lack experience with the regulatory framework which might prevent them from launching their business.

Yet, regulation is necessary. Most infrastructure services are natural monopolies, whether in public or private hands, and the temptation always exists to abuse this position through monopolistic pricing or negligence of services. A final regulatory concern occurs when consumers lack information to assess the quality of the service they get and about environmental standards, public health, and safety. Therefore, operators also have to be subject to regulatory controls, which should strike the right balance between regulation and flexibility.

Working on rural electrification regulation touches upon two main domains central to increasing the programs sustainability: general regulation and policies; and contractual agreements regulation. It often revolves around the issues of simplification, generalization, and standardization.

⁴⁹The World Bank counted about 150 such enterprises operating in Bolivia, at least 200 in Cambodia, and several hundred in Ethiopia “Electrification and Regulation: Principles and a Model Law Paper.” Paper No. 18, World Bank, 2006.

First of all, it is important that small operators in rural areas are not confronted with the same level of regulation as large organizations like utilities. One solution often proposed is to create different categories of rural off-grid suppliers based on their load size, and to define administrative procedures accordingly. For instance, in the smallest load categories, which typically would include rural electrification mini-grids, operators would have no obligation other than to register themselves and provide yearly updates of basic information.

The balance between flexibility and regulation is also central in the process taking place for the fixation of the energy tariffs. While tariffs should be adapted to local circumstances, the question is how to regulate them. An option is to publish Tariff Tables that specify a maximum allowed retail price for mini-grid operators under certain circumstances, but leave them the liberty to charge any price up to the maximum.⁵⁰ The intent of such a framework is to relieve the operators of the obligation to make an initial tariff filing with the regulator by standardizing the procedure. This process has several advantages: it gives the operator the flexibility to adapt to end-users' ability and willingness to pay; it facilitates the pricing procedures; and it gives some insurance to potential operators who must know both tariff and subsidy levels before they can make investment decisions. The ceiling, however, must be adjustable and regularly revised.

Managing regulations for small operators active in rural areas is especially important when it comes to the contractual agreements between different actors involved and, more specifically, the diverse contracts of electricity supply (including Power Purchase Agreements -PPAs). Different aspects have to be looked at in depth, including balance of responsibilities, enforceability, length, and tariff settings.

In principle, most developing countries have opened their markets to private sector generation and supply of power (to the national grid or through decentralized systems). However, national utilities often have a monopoly on the purchase and distribution of wholesale power and small suppliers remain dependent on a single state buyer. Therefore, it is imperative that the overwhelming bargaining power of the utility be mitigated and that it operates in its role of purchaser and transmission entity subject to objective PPA and tariff principles. In South Asia, this market uncertainty was overcome by instituting standard PPAs, a standard offer from the national utility to purchase all energy produced by specific renewable energy-based independent power producers at a pre announced price.⁵¹ This type of standardized process has proved to be key to enhancing the transparency of the market and to scaling up small renewable energy investments. Moreover, standard power purchase agreements from the local electric utility can be vetted and approved by lenders in advance, which will reinforce the position of the private operators in local or international financial markets. In general, standardized contractual documents decrease the administrative costs, increase efficiency and greatly simplify procedures for new participants in the electricity market (see Philippines case study, Section 4.2).

PPAs must provide a fair, neutral contractual arrangement between the power seller and purchaser, but most of all, they must be contractually binding in order to maintain investor confidence and long-term program viability. Unilateral changes, especially from the dominant actor that is the utility, must be banned and the sanctions of non-performance between the buyer and the seller should be comparable, while in many developing countries they are often disproportionately placed on the seller.

Regulations must lay out clearly the utility's commitment to purchase excess power produced at an attractive tariff since lack of assurances usually limits the size of renewable energy projects. This type of regulation should not be reserved for utilities, but should be encouraged at every level of the project chains (and especially between communities). The lack of regulation encouraging small industries to sell excess power to neighboring rural communities is often resulting in under-sized projects. Therefore, connecting agreements across rural areas would help increase project size and create economic synergies.

An additional complication, especially in Africa, is that utilities often are threatened by a lack of liquidity. As a result, operators are not willing to discuss with them unless the contract is clearly supported by the state. In this context, the buyer has also to be supported. The utility cannot be the only one bearing the financial weight of supporting rural electrification incentives.

Several cases exist throughout the world where utilities changed the contract terms during PPAs, which adversely affected the independent power producer's operations. In Indonesia, for example, a series of unilateral changes in the PPA, including revisions to the tariff structure, led to problems of price stream uncertainty and undermined project finance. The Thai rural electrification program foresees reducing the small power producers' payment when the producer does not deliver, but has no equivalent sanction against the utility for failure to purchase power.⁵²

50 "Electrification and Regulation: Principles and a Model Law Paper." Paper No.18, World Bank, 2006.

51 "Module 9: Regulatory and policy options to encourage development of renewable energy." UNIDO, REEEP.

52 "Power Purchase Agreements for Small Power Producers." Steven Ferry and Anil Cabraal, ESMAP, 2006.

This issue also concerned the Moroccan ONE utility and the Moroccan Global Rural Electrification Program (PERG). If the PERG is often presented as a great success with an electrification rate of rural villages around 97%, the part of this program which has been realized with renewables has raised some issues regarding the policy of the very powerful ONE. Several members of the Alliance that acquired a concession in PERG had concerns about the execution of the program. Specifically:

- Only around 40% of the systems that were planned in each concession have actually been installed (representing a vast difference between the potential figures given to the companies by the ONE in the tenders and the actual installation). As a consequence, the concessionaires receive only a fraction of the anticipated revenue (allocation of the basis of a fee for service model).
- Furthermore, ONE has changed its grid extension plans regarding the regions covered by the off-grid renewables before the 10-year period originally planned, taking out much interest in the long-term off-grid concessions.
- Finally, the utility has refused to update the subsidy level allowed, despite these dramatic changes and the increase of costs that has occurred due to the raw material markets worldwide. These events have had severe consequences on the companies involved, which have sometimes survived only because they were linked to important European groups.

Penalties for not respecting a contract have to rest on each stakeholder. For instance, disconnecting an end-user who refuses to pay the electricity service is essential (see case study TTA, Section 4.1), but these sanctions are needed at each level. For the operator, the incentives (subsidies, attractive tariffs, connection support) can be maximized if they are coupled with the energy payment and linked with the delivery (output-based). Finally, as explained above, the utility as a dominant player should be particularly watched for the protection of the other parties.

The length of the contract (between an operator and a utility or a community) is also a controversial question. In many developing countries, licenses are still issued for periods that are too short to allow an operator to recover the investment costs and make a decent margin. Longer-term licenses or PPAs help ensuring that the price of electricity charged by the operators is moderate, while giving investors sufficient time to justify their investments.

Pricing is of course central in a PPA, especially between private and public parties. Many governments turn to the private sector when they cannot afford to keep providing free or inexpensive services, or the capital expenditure required to extend services. Allowing power producers to raise prices when they take over the generation of electricity can have some political consequences, but ignoring market forces and suppressing price hikes can push businesses to back out.⁵³ Tariffs spelled out in PPAs must be flexible, revisable, and take into account changes in the marginal cost of generation in order to reflect either estimated long-term or short-term avoided cost for the utility.⁵⁴ However, as the Moroccan case study suggests, there are still many utilities that resist adjusting the tariff to fully reflect these costs.

If projects wish to attract foreign investors, they might seek to index as much as possible PPA tariffs on foreign exchange to offset the risk of currency devaluation, as well as increase access to international finance for project developers. This would ensure that the project cash flow is held constant in the converted currency in which international investments are sourced. For example, during the 1997 global financial crisis, some Thai projects that had borrowed in foreign currency were receiving PPA payments in Baht, and the currency devalued dramatically, leaving operators in a de facto state of bankruptcy.⁵⁵

53 Leaving infrastructure services to the private sector either through PPAs or privatization does not always lead to price increases. This depends on three factors — the extent to which the private sector can introduce efficiency improvements, how far prices were below cost recovery levels, and whether the higher cost of private finance requires price increases. “Nepad Policy Focus Series: Working Together Assessing Public-Private Partnerships in Africa.” The South African Institute of International Affairs. 2005.

54 Avoided cost are the cost to a utility of acquiring power either by purchase or by constructing additional generating capacity itself and generally deemed the equitable foundation on which to base the tariff structure of a PPA.

55 “Power Purchase Agreements for Small Power Producers,” Steven Ferry and Anil Cabraal, ESMAP Knowledge Exchange Series No. 7.

Lessons learned:

- Regulation has to be an instrument favoring new projects, not a burden. It needs to be light and flexible for small power producer in terms of standards and tariffs. It also has to protect rural consumers.
- PPAs must be fair and binding to protect every actor equally. They must be enforced and unilateral changes must be banned and punished. Companies have to be protected but utilities should also be backed up to reinforce their credibility. Political power has a role to play in supporting the efforts of the utilities in reaching the most remote areas.
- PPAs should be as standardized as possible. This decreases administrative costs, increases efficiency and greatly simplifies procedures; but most of all it enhances market transparency and helps to attract operators and support from lenders.
Power agreements should be encouraged between all rural stakeholders and especially between communities.
- PPAs should be signed over longer period of time and should be flexible and revisable when it comes to tariff. Finally, they should be indexed to foreign exchange rates to offset the devaluation risk and encourage long-term investments from foreign sources.

CONCLUSION

Hybrid mini-grids incorporating renewable energy can be a cost-effective means of supplying affordable and reliable power to rural communities. However, such projects require capacity building at every point of the project chain, and with every stakeholder. Capacity building work, from project inception to the operation of the system and the organization of the local social structures, must be factored into the cost and timeframe of project development upfront in order to ensure the sustainability of the investment.

There are various models of ownership, each with its own strengths and weaknesses. Consideration as to the best form of ownership will vary from community to community and must take into account the model best suited to local stakeholders. When compared with 100% diesel-based systems, the lower operating costs of renewable energy systems improve the ability of rural communities to cover their O&M costs. However, some form of subsidy will most of the time be needed to cover at least part of the capital costs for the foreseeable future. However, this amount will steadily decrease as technology costs decrease and experience increases.

Some key points to observe when considering development of a hybrid micro-grid are:

Obtaining Local Buy-in

Since long-term viability of the system depends on the satisfaction of its users, it is imperative to include them in planning and encourage participation from local leaders during each phase of the decision making process.

Community-run mini-grids have myriad positive impacts on the community in terms of self-governance and local buy-in into the electrification system. However, a long preparation period including technical and capacity building is imperative to compensate for the lack of skills and potential social conflicts. Local ability to deal with serious technical issues could also be a problem, thus adequate training programs must be developed.

Local stakeholder involvement from project inception is fundamental, regardless of the ownership of the system. By utilizing local village authority structures, participation can take many forms from project to project to assess, monitor and best meet community needs.

Strategic Planning

Projects should be designed to support the development of a local private sector to generate increased revenues within the community. The system design should not be driven by pure technological considerations, but instead adapted to the specific social and economic characteristics of the rural community.

Electrification programs should seek to develop rural, non-electrified areas in the most sustainable way. Creative strategic planning may lead to different ways of involving local business, including the support of technology transfer, the formation of new alliances with local companies, and provision of local technical and business training.

Positive community impacts can best be maximized by providing information through education and training with strong, targeted messages conveying the benefits of energy access. Projects can be built around existing business applications or public institutions to increase critical mass, potential profits, and local involvement.

A long-term investment perspective on hybrid mini-grids is essential when developing financially sound projects. Successful rural electrification programs incorporate vast networks of local businesses for training, O&M, spare parts and access to finance at all project levels. Targeted marketing around the call for tenders and program are key to increasing private sector participation.

A sustainable rural electrification tariff must cover operation, maintenance and replacement costs. It is imperative to find a balance between commercial viability and consumers' ability and willingness to pay. Connection fees have an important role, as does tariff collection.

Regulation

Strategic combinations of subsidies and well-designed tariff structures will attract operators and lead to sustainable project designs. Properly crafted regulation should be an instrument favoring new projects, as opposed to burdening them.

Power agreements between all rural stakeholders, communities and power providers should be as standardized as possible to decrease administrative costs, increase efficiency and simplify procedures. Regulation should be flexible for small power producers' standards and tariffs while also protecting rural consumers.



1. Hybrid Technologies and System Design Issues

1.1. Solar PV

Solar photovoltaic (PV) generators convert the energy from the sun into electricity through their solar cells, which are semiconductor-based materials. These solar cells are gathered together to form a solar panel. Each panel can have a peak capacity from 80-200 W, depending on size and technology. Panels can be installed together in order to achieve the desired output capacity.

The amount of solar energy received at a specific location is called insolation, and this factor determines the output of the PV generator. Solar resources are universally available at any location with higher values closer to the Equator. Therefore, PV systems tend to have higher performance in most developing countries than in North America or Europe. In North America, the insolation varies from 1,400 to 2,300 kWh/m², whereas in Tanzania values are in the range of 2,500 kWh/m² and in Afghanistan around 2,000 kWh/m². Although performance is site dependent, as a rule of thumb 1 kWp installed will produce more than 4 kWh per day.

Seasons have an influence on PV generation. During the warmer months the insolation is higher than in cold months. Similarly, insolation is higher during dry season than during the rainy season. In this scenario, the lower production of PV during the rainy season can be offset with a small hydro system which will operate at higher levels due to higher availability of resources in rainy and in cold months.

Of course, the time of day also influences the production profile, with peak production at noon when the sun is perpendicular to the Earth's surface, and no production during the nights. The normal strategy is to balance the hours the PV system is offline with stored excess power produced during the day and stored in a battery.

PV generators produce DC power and therefore extra components are necessary to adapt the voltage to the required applications (many loads and most of the grids). If the system includes batteries, normally the PV generator will be connected to the batteries through a charge controller. If instead the PV generator is connected to an AC bus bar feeder, it will need an inverter to adapt the voltage.

Solar PV has several advantages:

- Almost every location in the world receives solar energy daily, which makes PV technology the first option available for almost all hybrid systems. Small wind or hydro power plants are much more site specific and are suitable for fewer locations.
- Insolation is well known around the globe and does not vary greatly at the local level (unless there is direct shadowing on the structure, which should always be avoided). The long data collection periods required for siting wind or hydro resources are rarely necessary for solar.
- Solar PV arrays do not produce emissions or noise, as a photochemical process generates electricity, instead of mechanical devices for absorbing the kinetic energy (as is the case with wind or hydro technologies).
- PV panels are comparatively easy to install and can be set up by local qualified technicians with some training. It is necessary to choose the best orientation of the PV panel structure in order to maximize energy production with respect to the load.

Although the cost of PV electricity is generally higher than energy produced by small wind or hydro, prices for PV panels have been decreasing dramatically in the last few years (see figure 12). Currently the price of a reliable PV manufactured panel is below US\$ 3/Wp, with prices expected to decrease even further. Of course, these favorable prices are valid exist for the most developed markets in Europe or the US. In developing countries, prices can be substantially higher. This is mainly due to inefficient distribution chains, customs duties and lack of competition.

Figure 12. US PV power sales prices ⁵⁶

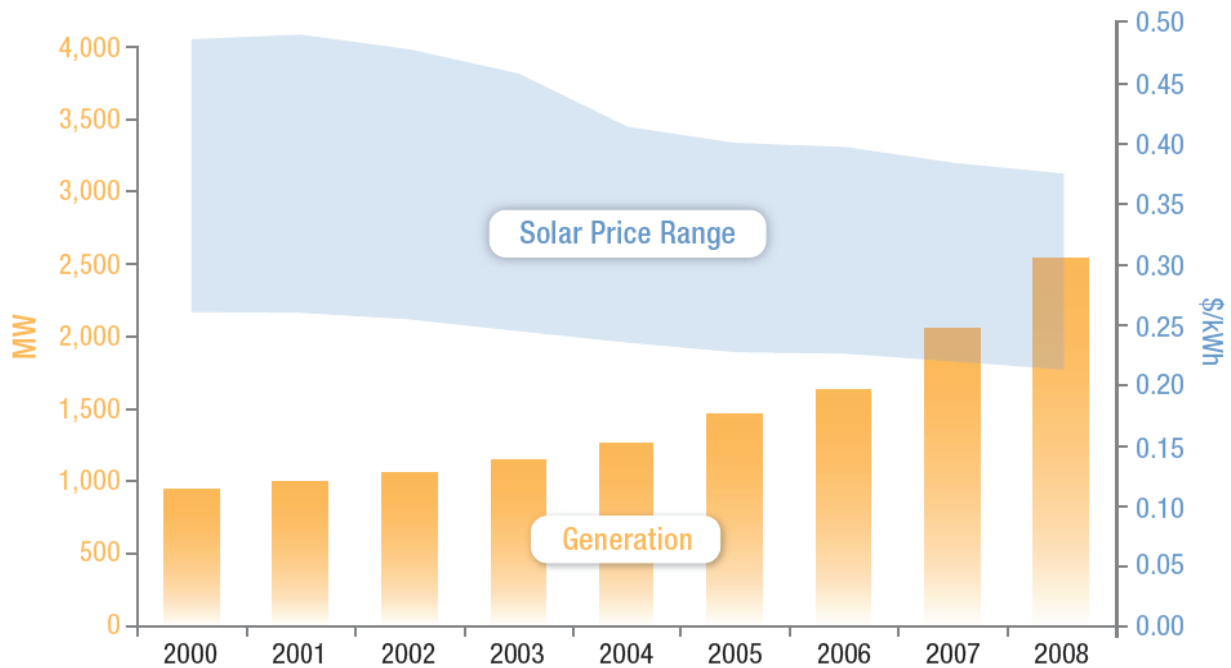

1.2. Small wind

Wind turbines convert the kinetic energy from wind into electric energy. Hybrid mini-grids use small wind turbines ranging from 1kW to 20 kW. Larger turbines also can be installed although this will increase the complexity of the system and require higher construction costs for foundations and control stations. There are a variety of technologies in the small wind turbine market; however, for installation in rural communities in developing countries, it is important to rely on well proven and mature technologies with high quality standards to ensure optimum performance during the project lifespan. Horizontal axis models with 2 and 3 blades are the most common models used in current hybrid power systems. To meet local demand, several small wind turbines often are installed.

Wind resources are extremely site specific. Topography and obstacles highly impact wind speeds, so turbines are normally located along ridges and hilltops at a height of at least 10 meters to minimize the influence that buildings and trees can have on the wind profile. This is an important consideration, given the fact that rural communities often are located on lower parts of slopes and in valleys. For this reason, gathering information on local wind resources throughout the year is necessary prior to the final decision on the installation. Normally wind speeds in the range of 4 to 5 m/s are the minimum to make a system profitable. Selection of turbines especially designed to work under low-speed winds can be a good idea, depending on the wind information collected.

Wind power also is subject to both seasonal variability and daily intermittence. This makes hour-by-hour and day-by-day evaluations of the expected production critical, and require the combination of wind with other technologies. For example, batteries can provide stable supply of electricity to the grid for short periods when the wind is not blowing. For longer periods of low winds it may be necessary to use more genset power to match the users' demand.

Small turbines of a few kW capacity normally produce DC power at 12 or 24 V through permanent magnets. In most cases, larger turbines produce AC power through induction. Depending on the architecture of the system, wind turbines may need an AC/DC convertor to charge the batteries directly; but if the bus bar is on AC, the turbine can be connected directly or just with an AC/AC converter to stabilize the components.

56 US DOE 2008 Renewable Energy Data Book.

1.3 Micro-hydro

Micro-hydro turbines convert the kinetic energy from a river stream into electricity. The smaller sized turbines, from 0.1 kW to 5 kW capacities are also known as pico-hydro. However, for hybrid mini-grids, turbines with sizes up to 100 kW are more realistic. Of the three renewable energy technologies detailed here, micro hydro is the one which requires the most infrastructure work. The canalization of the water stream that will run through the turbine and the construction of the building to protect the generator from damage or the risk of compromising the security of neighboring structures or land increase the capital investment. The capital costs can be shared if other water services such as irrigation for agriculture and domestic water supply are constructed at the same time. If the hydro project is undertaken in conjunction with these other water-related projects, the decision should be taken at an early design stage to install a larger diameter pipeline to meet all the water needs. In fact, pipe diameter for micro-hydro power plants needs to be much larger than those for domestic water supply in order to minimize friction losses, so it is not possible to use an existing domestic pipeline for power purposes.

Micro-hydro resources are also very site specific. Small hydro power plants need to be located relatively close to the villages and to a river to reduce transmission-related energy losses. However, the mere existence of a river is not sufficient. The water source needs to provide the right combination of flow (liters/s) and fall (m), although there are several models in the market specialized in low head and high head conditions. Gathering information on the stream flow over the course of a year is necessary to estimate energy production potential prior to the project. The monthly distribution profile will determine the minimum production of the system.

Some rivers have a seasonal variability of their stream, and the system will not be able to run during certain months when there is insufficient water flow. In this case, a diesel genset or other RETs have to be integrated into the mini-grid to supply the village.

Micro-hydro systems have several advantages:

- The electricity production is continuous, without interruption as long as the water is flowing.
- Although initial construction costs are high, they can be reduced by employing locals for the construction.
- Projects less than 100 kW tend to have a minimal environmental impact on the river. This will depend on the chosen design (water canalization, a side channel, or a small dam). Side channels divert only a small fraction of the river and have a smaller impact than dams. However, dams can be used as fishing ponds or washing areas and their flow rate is more stable.
- It is the cheapest and most reliable technology to generate electricity, although the one with most specific site requirements.

1.4 Diesel genset

Diesel generators have commonly been used in rural electrification for years, though this technology is rarely the lowest-priced option, in the long run. The gensets used in rural villages typically range from 1kW to several hundred kW capacity, depending on the load demand and on the capacity of the RETs in the hybrid system. The smaller sizes, under 5 kW, normally use gasoline as fuel, but larger-capacity generators rely on diesel fuel. Some engines run on natural gas (LPG), oil, or biofuels.

Within hybrid power systems, the advantage of diesel genset is their dispatchability. Gensets improve the quality of service and the security of supply as they are able to balance the intermittent production of RETs. For example, gensets will be working when renewables are not generating, or when the battery reaches a low Stage of Charge (SoC). It is very important to bear in mind that in developing countries, and especially in rural areas, the provisioning of fuel is an arduous task. Isolated villages always have to consider carefully their fuel reserves and calculate the amount needed to drive a truck to a city and bring more fuel.

The volume of fuel required to run a genset for a whole village with a 100% direct genset operation is extremely large and normally special storage facilities need to be installed. For instance, to generate 1 kWh of electricity,

a genset will consume at best 0.3 to 0.4 liters of diesel fuel. Diesel gensets in hybrid systems are smaller and therefore consume less fuel.

Gensets normally supply AC power and can be connected directly to the distribution feeder bus bar. If battery is part of the hybrid's configuration, then an AC/DC converter is needed.

The lifetime of a diesel generator is normally between 3 to 5 years of continuous operation. In hybrid systems, the strategy is to use as little fuel as possible to reduce the expenses and maximize the lifetime of the generator, ideally to 20 years and more. However, when gensets need to be used, they have to run on high capacities not to reduce the lifetime of the generator. Nowadays modified generators can run on biofuels such as jatropha. This proved to be the case in Mbinga in Tanzania, where biofuel based on jatropha is locally produced by the Vincentian Sisters.⁵⁷

The reduction of gensets' use has advantages not only for the cost and availability of fuel resources, but also has environmental benefits. Gensets' motors of course produce CO₂, but also generate local air pollution and noise. The less diesel generators are used, the less fumes will be produced from burning fuel. Special ventilation measures should be taken when constructing the generator building.

1.5 Batteries

A battery is formed by series of electrochemical cells connected together to match the required voltage. The most common type of battery used in a hybrid micro-grid is the lead-acid, deep cycle type, although many models are available in the market. For instance, car batteries are often used in developing countries for small appliances such as mobile charging or lighting. However, this type of cheap short-cycle battery is not recommended for hybrid power systems.

The batteries can be a significant factor in the cost of a hybrid power system. The battery is normally replaced every 6 to 8 years, but improper operation and maintenance can drastically reduce its lifetime, and therefore considerably increase replacement costs. In order to improve the batteries' lifetime the system must be properly operated and maintained. For instance, it is important to check the electrolyte levels every 2 months and to fill the batteries with distilled water instead of normal water. This is a common and fatal mistake. Battery operation must also be carefully checked: A battery normally should never be operated under 50 or 45% State of Charge (SoC).

The mission of the battery is to provide power when renewable energy sources are unavailable. The frequency of periods without renewable generation, combined with the necessity to maintain a state of charge above 45%, will help determine the sizing of the battery capacity. This decision will of course have a dramatic impact on the total system costs. This is also a quality requirement depending on the customer's need. For example, a health center may need a higher security of supply, requiring higher battery capacity which boosts the system price. A diesel genset will reduce the battery capacity needed as it can run whenever SoC is low. The question of balance between a larger battery capacity or the use of more fuel is a sensitive cost analysis which is discussed above.

The storage also presents other challenges. The acid and lead components are dangerous for the environment and need to be properly collected when the battery is disposed, which may be difficult in some regions. In general, improper disposal of batteries can have serious impacts on the local environment, polluting both water and soil. Operating and maintaining battery can be challenging, and inappropriate usage is a common cause of system failure or malfunction.

Storage technology is developing rapidly, thanks to research and development in the transportation sector. Some of these innovations like the widely known lithium-ion technology are already being used in developing countries (i.e., innovative solar home systems). However, there is little experience on how these new technologies behave in the long run under typical conditions of mini-grids. Pumped water storage (pumping water into a highly located reservoir and releasing it to create energy when needed) has been tested as an alternative to battery electrochemical storage, but those systems, despite their advantages, are rarely used mainly because they are site specific, expensive, and less familiar.

57 Energiebau Solarstromsysteme GmbH.

Lessons learned:

•	Solar resources for PV are well known for any location in the world. Developing countries often have higher resources than developed countries, where the technology has been massively developed.
•	The main advantage of PV is that it is suitable for almost any location, though initial costs can be more expensive than the other technologies.
•	Small wind power technology is site specific and its installation and resources must be carefully studied beforehand. However, prices are normally lower than PV.
•	Micro-hydro is the cheapest renewable technology, but the most site dependent, as it requires a river with specific flow rate and volume conditions.
•	The lifetime of batteries must be maximized as battery costs play a major role in the project costs. It is important not to reach often a full SoC between cycles and to avoid prolonged deep discharge, but this can be managed by using a diesel generator as a backup.
•	The use of diesel gensets normally is minimized as fuel is costly. Genset use ensures the quality of service when all other technologies are down or when demand is especially high. Having a diesel generator as backup also maximizes battery lifetime.

1.6 Mini-grid configuration

Components coupling: AC vs. DC bus bar

The selection of the bus bar depends on the technologies used in the system and on the energy management strategy. While PV and batteries run on DC, electro-mechanic technologies such as gensets, small wind, and small hydro normally produce AC power.

In hybrid mini-grids the use of AC bus bars is more common when the battery is the central component of the system; a bidirectional master inverter can be installed to control the energy supply between AC loads and battery charge.⁵⁸ Village mini-grids often rely on an AC bus bar since the efficiency is higher, the losses lower and the system is more flexible and expandable, although the wiring is more complex. Regarding costs, the difference between both types of installation is negligible.

Single vs. three-phase distribution line

The distribution grid lines are either on single-phase or three-phase. The use of three-phase most of all allows the connection of higher energy consuming appliances which can be used for income generating services such as carpentry. The existence of services is more likely in larger villages and hence, larger capacities. The three-phase grid has other advantages, such as the possibility to connect the mini-grid to an existing regional or national grid (if the voltage is the same). The three-phase grid is more complex and needs more conductor lines, but is also more easily expandable. Finally, it is important to remember that if it is technically feasible, the use of single-phase grid has a few advantages. For example, the loads do not need to be balanced, and for the same size there is more surge capacity. It also reduces the costs while allowing an expansion on the generation capacity in the future.

If only a few appliances in the village require three phases it can be worthwhile to invest in phase converter instead of designing a three-phase system.

⁵⁸ "Hybrid power systems based on renewable energies: a suitable and cost-competitive solution for rural electrification" Alliance for Rural Electrification. 2008.

Different configuration models

- Electricity generation coupled at DC bus bars

Figure 13. Coupled at DC bus bar⁵⁹

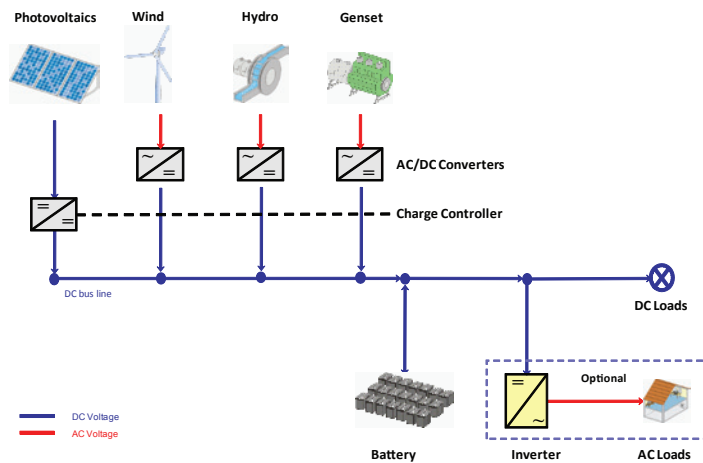

- Electricity generation coupled at AC bus bars

Figure 14. Coupled at AC bus bar⁵⁹

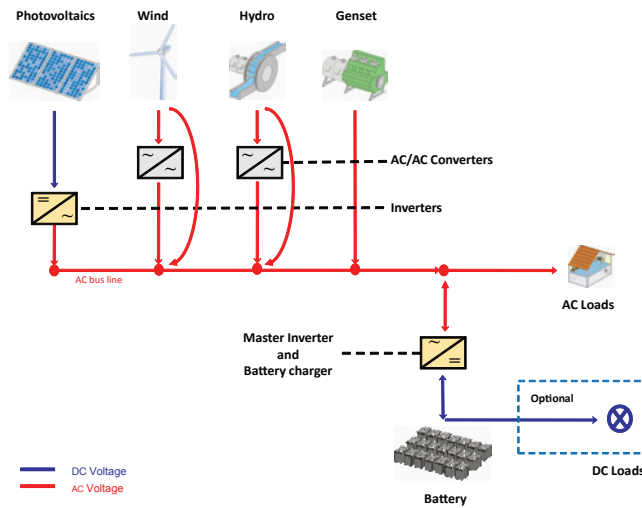

- Electricity generation coupled at AC/DC bus bars

Figure 15. Coupled at AC/DC bus bar⁶⁰

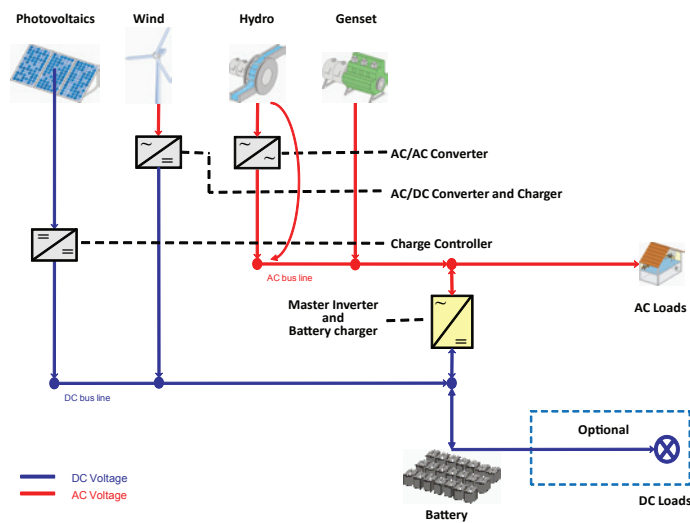

59 Hybrid power systems based on renewable energies. Alliance for Rural Electrification, 2007.

60 Hybrid power systems based on renewable energies. Alliance for Rural Electrification, 2007.

Lessons learned:

- AC and DC coupling are common on hybrid mini-grids. However the selection of AC or DC depends on the load profile and the technologies to be coupled in the system.
- The existence of a battery (DC) and its role in the system also affects the decision on current type (AC vs DC).
- Single-phase distribution grids are cheaper than three-phase and can also allow productive uses. However, three-phase grids allow larger uses and the possible of future connection to the national grid, but only if the mini-grid has the same technical standards.

1.7. Sizing the project

A cost-efficient design of a hybrid power system must precisely match the production capacity and local demand. Unintentional over-sizing of the capacity will result in unnecessary costs. For example, the oversizing of generation capacity increases the already high capital costs, producing a surplus of electricity which is not used. In the case of diesel gensets, oversizing can have a negative effect on the generator's lifetime, as well as a higher fuel consumption rate, as gensets need to run at between 50-80% capacity. Oversized battery banks increase capital costs as well. However, to under-size capacity results in unavailability of power and resulting dissatisfaction among end-users, which can lead to the failure of the project (which can have dramatic regional impacts, as the consumer's satisfaction is vital not only for the project, but also for its broader replication). Under-sizing can also result in higher stress on the components, lowering unnecessarily their lifetime. In both cases, the levelized cost of energy is negatively affected.

1.8. Demand load dimension

In order to install the correct production capacity, precise estimates of demand are needed. In a simplified way, the demand is equal to the number of users multiplied by the estimated average use of electricity per user. However, this approach is not really sufficient as the margin of error is quite large for a village-sized project. Instead, it is better to aggregate the estimated electricity demand of each potential user, considering domestic, public services, and economic services.

Estimating electricity demand requires intensive door to door field work. Two factors are important, the **user's willingness to be connected** and the **consumption of the electricity appliances** that will be used once connected. Both factors require a full understanding of the organizational, cultural, and ethnological structures of the rural community. For example, it is important to understand the role of men and women and their use of electricity depending on their daily tasks, the village's education needs, and other factors. In addition, the demand varies during the day and throughout the year. Domestic users will use more electricity during evenings (for lighting, entertainment, and cooking), and reduce their use during the day. The distribution during the whole week and the definition of the peak demand are important as they define the maximum capacity that the system has to produce at a precise instant. The hybrid mini-grid has to be prepared to supply all the users' needs.

Education of end-users on the uses of electricity is important. Wise consumption can help prevent system blackouts. Consumers need to understand that in some situations, for example long periods of low resources, the power system cannot support the use of many appliances at the same time. Disconnection of certain appliances can assure the supply of priority applications such as health services with vaccine refrigerators and other minimum necessary services.

The issue of overdimensioning has to be carefully considered and addressed right from the early design stage. After the first years of electrification, demand is likely to grow, for several reasons. First, the improvement of living conditions and the local economy allows users to purchase more appliances and new local enterprises may open, bringing about demand increases. Second, the number of users is also likely to increase because the electrification benefits have an impact on reticent users unconvinced about the technology (the new technologies are not always welcomed by everyone and the rate of adoption normally follows a bell curve); and because the villages themselves grow and expand. To meet the increase of the demand without compromising the service quality, some components of the system need to be oversized. One common practice to avoid sharp increases in system costs is to build in 30% extra capacity, mainly in wiring and batteries. The generation technologies can be scaled up afterwards according to the demand.

1.9. Load Management strategies

The main goal of a hybrid power system is to match the resources with the demand for energy.⁶¹ Due to the combination of the different technologies, it is important to manage them correctly to maximize the performance and decrease costs. There are a few general guidelines which are related to the cost of electricity, primarily focused on the use of fuel and the battery bank, and their relation with the lifetime and the replacement costs.

- **Use of fuel**

As a general rule, renewables generation should have the preference over diesel generation. Whereas the marginal cost of generation with renewables is zero, each kWh produced by the genset requires fuel and increases the energy price. For this reason the use of diesel genset can be mostly cost-effective as a back-up when the production of renewables is not sufficient to meet a short daily peak demand or when the battery has a low SoC. However, there are alternatives to reduce the use of fuel. In some systems in Inner Mongolia and China, the local operator in charge of running the system decided not to run the genset to avoid the fuel cost, and users accepted the blackouts. Unfortunately this strategy put a greater stress on the battery bank, reducing its lifetime.⁶²

- **Use of the battery**

To avoid damaging the battery, its SoC should not drop below 45%, and should never reach less than 25%. This seriously damages deep-cycle batteries, decreasing their lifetime and therefore increasing the replacement costs. Gensets can help avoid this situation by compensating when these levels are reached. However, the diesel generator lifetime is also reduced by frequently on/off cycles, and the generator should run at a capacity between 50-80% for good performance. In practice, this means that the management system should start the genset when the battery is near 25% SoC and let it run until the battery is fully charged again. An interesting example of management can be found in the Moroccan project from TTA mentioned in section 4.1. In this case, SoC levels were getting low late at night, just a few hours before the load and the consumption were going down drastically. When the 45% SoC was detected, the diesel generator was starting up, then running the whole night until the battery was fully charged. In the morning when the sun was shining again, the PV generation was only partially used (catering for the actual consumption) because the battery was already charged, resulting in unnecessary fuel expenses. Therefore, the operator decided not to run the generator during the night and to accept to increase the stress on the battery for a short period of time until people went to sleep, saving fuel and taking advantage of the sun to charge the battery.

An important decision is whether to run the energy management system (EMS) automatically or manually. Both have pro and cons, but this decision depends largely on the ability of the local operator to run the system properly and to preserve the equipment. An automatic EMS is the less risky option as it does not rely on human decisions. The system detects when the SoC is low and starts up the diesel generator, without compromising the lifetime of the equipment. However, there are situations where human oversight is necessary, such as the impossibility of adapting the production to weather and load forecasts (a local operator can estimate the resources for the next hours and decide whether to run on diesel). Unpredictable consumer behavior, moreover, can result in over consumption of fuel, pushing the community to completely switch off the automatic EMS in order to save money. This can be fatal as local operators do not have the knowledge to run the system precisely and as the battery would be seriously endangered by these high stress situations. A manual system can be run poorly if there is insufficient training of the local operator; however, if the EMS is manual, semi-automatic measures can still be implemented without risk of switching them off, such as a system disconnection policy when the battery reaches 25% SoC, a safeguard adopted in the Moroccan example.

Regardless of the chosen option, rural people and local technicians need to be trained by project developers. The unpredictability of external conditions and of human behavior makes the need for local knowledge irreplaceable in any case.

61 "IEC/TS 62257-2. Recommendations for small renewable energy and hybrid systems for rural electrification - Part 2: From requirements to a range of electrification systems". EIC. 2002.

62 "Integrated analysis of hybrid systems for rural electrification in developing countries" Gül T. 2004.

Table 5. Advantages and Disadvantages of Energy Management Options ⁶³

Energy Management System	Advantages	Disadvantages
Automatic	<ul style="list-style-type: none"> - Under standard conditions, optimization of life-cycle costs - Can be easily managed from a remote location 	<ul style="list-style-type: none"> - Investment costs and need for further technological training - No anticipation of weather conditions - Not able to handle exceptional demand circumstances (one-off events) - No capacity to take into account short term cash flow problems - No capacity to take into account diesel availability (and unexceptional prices)
Semi Automatic System	<ul style="list-style-type: none"> - Can combine pros and cons of both systems, while leaving a margin for adaptation and unpredictability 	<ul style="list-style-type: none"> - Leaves a margin for adaptation and unpredictability
Manual System	<ul style="list-style-type: none"> - Flexible management, especially under exceptional conditions (weather, supply of diesel etc.) 	<ul style="list-style-type: none"> - Requires knowledge about long-term effects of decision - Tendency to prefer short-term gains over long term cost optimization - Requires 24/7 availability of the technician

Lessons learned:	
•	Correctly estimating demand and sizing production capacity accordingly is central to determining the final electricity cost for the consumers. This is especially relevant in systems when initial fixed costs are high and prices need to be spread over the lifetime of the project.
•	Face-to-face questionnaires and exhaustive analysis on consumer demand and willingness to pay are a basic requisite.
•	Oversizing by 30% some components such as the wiring and the converters can easily allow for future expansion of the mini-grid.
•	Use of battery and use of fuel are closely related, and they keep a balance on the cost structure of the project.
•	Automatic or manual EMS has different advantages and the decision will depend on the local operator's experience with running the system. However, there should always be some automatic measures to protect the components from severe damage, such as total depletion of battery charge.
•	Training of local operators and users is required to ensure that components are used correctly and will last the projected lifetime.

2. Energy efficiency

For mini-grids, energy efficiency is a crucial factor for success since it has a direct impact on the dimension of the RE generator capacity and hence the initial investment costs. Measures which bring down the anticipated energy consumption (demand side management measure) require intensive and sustained interaction with the end-users. In rural electrification projects, energy efficiency is less a technical issue, but mainly concerns capacity building, training, and ongoing involvement of the end-user.

63 Alliance for Rural Electrification.

One of the key challenges is a phenomenon called “the economics of poverty.” Poor people tend to choose the lowest upfront investment and shy away from higher investments which pay off over time. This is partly due to limited cash and lack of micro-financing, but has a strong psychological component as well (the attitude of not being able to invest in expensive equipment and a strong focus on the near future).

This psychological factor is important over the lifetime of the system. Even if energy-saving bulbs (CFL) are part of the initial equipment there is a strong tendency to replace broken CFLs with cheap incandescent bulbs, so that the energy consumption may increase over time due to efficiency losses. The following measures can work against this tendency:

- **Ongoing dialogue and education of the end-user**
- **Local availability of energy-efficient appliances**
- **Possibility of achieving micro-credit for energy-efficient appliances**

There are output-based aid schemes for solar home systems which subsidize the upfront investment costs including energy-efficient appliances (the dealer model of the World Bank), as implemented in Ethiopia (Ethiopia Electricity Access Rural Expansion Project II – EAREP II). However, it is evident that these schemes run the risk of efficiency losses over time which for SHS may also exacerbate the problem of capacity losses of the battery. The “economics of poverty” also explain why there is a strong tendency to replace solar batteries with ordinary car batteries. Incandescent bulbs combined with car batteries will necessarily lead to strong deficiencies and only a fraction of the potential performance in terms of hours of light.

The local operator has a genuine interest in energy efficiency measures in order to prevent the mini-grid from being overburdened, and any resulting power cuts. However, this interest may not be high enough to convince the operator to provide mitigation measures in a systematic way. If there is financing available for scaling up the overall capacity of the system, the operator may have a strong preference for this option. In this context, another advantage of the self-organization of end consumers (energy-cooperatives) becomes apparent. Energy cooperatives and local committees act in the interest of their constituency and can extend their scope of activities to the measures to enhance energy efficiency.

The following case study involving a SolarWorld project in Bamako, Mali, highlights the crucial importance of energy efficiency consulting. In this case, SolarWorld focused on light bulbs, a fridge and a PC/laptop. The energy consumption without energy efficiency measures was expected to be around 7.800kW/h, which could be reduced by 76% to 1.880kW/h. The additional investment costs for the energy-saving appliances were 1,900 €, however the component costs were brought down by 14,900 € (See figure 19)

Figure 19. The relationship between energy efficiency and project cost⁶⁴

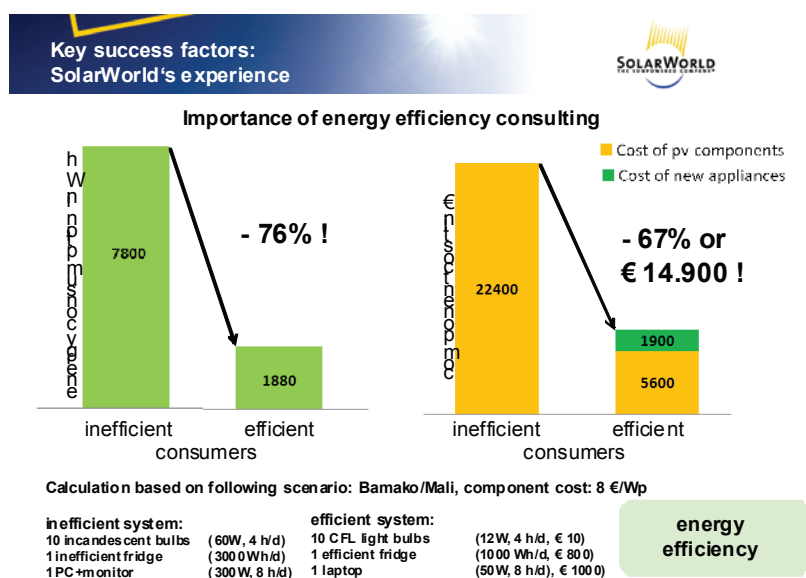

64 SolarWorld.

Lessons learned:

- Energy efficiency is a crucial component for the demand side management, the dimensioning of the mini-grid and as a consequence, the investment cost and financial viability.
- In many communities, there is a tendency for fading attention to energy efficiency and a strong focus on the reduction of short-term investment costs. Hence, there is a need for ongoing awareness raising and local availability of energy-efficient appliances.

Project designers face the challenge of designing a cost-effective and reliable system. Given that various components of hybrid systems must be replaced on a regular basis (with the notable exception of micro-hydro systems), the anticipated life cycle costs are of primary importance. Deficient components can jeopardize not only the smooth functioning, but also the financial viability of the business. International standards can be used to safeguard quality and sustainability.

IEC Technical Specification Series 62257⁶⁵ is a comprehensive set of standards covering the technical and organizational aspects of mini-grids. These standards provide a comprehensive and logical framework for the design, installation, and maintenance of mini-grids, with a particular emphasis on safety, user friendliness and efficiency. Moreover, the standards give an overview on important contractual questions and technical implementation plans (Series 3 project development and management). Business plans, financing schemes, and the range of social challenges (embedding into the community) are not covered by this series.

The IEC 62257 is new in the international off-grid community and therefore is not commonly used as a guiding reference. However, the IEC 62257 series serves as a checklist for good practices. Following these recommendations can ensure that project developers pursue a comprehensive logical framework. However, the IEC 62257 cannot guarantee that project developers make the right decisions (i.e., in terms of dimensioning).

Since the IEC series 62257 can be seen as a series of checklists, it is possible to envisage the self-declaration of planners and installers that they have complied with the approach suggested by this series. This would require comprehensive reporting which gives answers to all relevant aspects suggested by the series. In this sense, the IEC series could serve as a solid technical quality standard. The IEC series was published from 2003 to 2008. Since the IEC series is more an approach than guidance on specific technology, it is not likely to be outdated quickly, even as technologies evolve.

For quality assurance purposes, it is useful to keep in mind the specific IEC standards for system components (notably PV modules and batteries). There are also industry standards regarding performance and safety standards for small wind turbines. Those are particularly important for the collection of objective and comparable data from wind turbine manufacturers, and in safeguarding turbine robustness and longevity. A complete performance profile of a wind turbine, including output for all wind speeds in the relevant range (3-12 m/s), is essential. A single arbitrarily chosen data point such as output at 8 m/s does not allow for a sound performance assessment and comparison between turbines. Various business organizations have developed or are developing standards for small wind turbines (British Wind Energy Association, Netherlands Wind Energy Association, German Wind Energy Association, and American Wind Energy Association). These standards are all driven by the intent to certify safety (resilience against strong winds) and enable easy comparisons of the performance between turbines (i.e., output at a standardized wind speed, performance profile at various speeds). They differ in terms of verification schemes and costs involved. A substantial difference between the standards is whether small changes in the construction of a turbine (ongoing optimization) renders the certificate invalid and requires full retesting.

It is good practice of PV module manufacturers to grant a performance warranty of 20 years. Many of them comply with IEC standard 61215 concerning quality and IEC 61730 concerning safety of PV modules. Also for PV modules, it is important to have solid testing for the performance and a datasheet which allows for comparisons. The German DIN 50380 lends itself as a standard for datasheets and labels. Every manufacturer can give a 20-year warranty, but this warranty is certainly contingent on the assumption that the company will still exist in the long run. System designers have to evaluate the question in terms of the company's history and product reputation, and assess whether a company realistically will be able to honor the warranty.

65 The International Electrotechnical Commission (IEC) is the leading global organization that prepares and publishes international standards for all electrical, electronic and related technologies. These serve as a basis for national standardization and as references when drafting international tenders and contracts. The IEC charter embraces all electrotechnologies including electronics, magnetism and electromagnetics, electroacoustics, multimedia, telecommunication, and energy production and distribution, as well as associated general disciplines such as terminology and symbols, electromagnetic compatibility, measurement and performance, dependability, design and development, safety and the environment. See: <http://www.iec.ch/index.html>

Table 6. IEC Standards Useful for Hybrid Grids

Standard	Explanation	Comments / Propositions
IEC 61427 (2005)	Secondary cells and batteries for photovoltaic energy systems	Add new technologies: Li-Ions Add classes to differentiate life expectancy as a function of cycle life results.
IEC 61215 (Quality) & IEC 61730 (Safety)	PV Modules	New combined standard 61215 & 61730, DIN 50380 for datasheet and label (performance indicator), ISO 9001 for the factory Performance warranty > 20 years.
BWEA Small Wind turbine Performance and Safety Standard	Small wind turbines	High costs of certification and need for new certification even when small parameters change.
IEC 62124	Verifies system design and performance of stand alone PV systems	
IEC 62257-1:2003 Part 1	General introduction to rural electrification	Introduces general considerations on rural electrification and the IEC 62257 series. This series intends to provide to different players involved in rural electrification projects specifications for the setting up of low voltage renewable energy and hybrid systems.
IEC 62257-2:2004 Part 2	From requirements to a range of electrification systems	Proposes a methodological approach for the setting up and carrying out of socio-economic studies as part of the framework of decentralized rural electrification projects. Also provides some structures as technical solutions that could be recommended, depending on the qualitative and quantitative energy demands, consistent with the needs and financial situation of the customers. Proposes electrical architectures to technical project managers to assist them in the design of the systems.

IEC 62257-3:2004 Part 3	Project development and management	Proposes a framework for project development and management and includes recommended information that should be taken into consideration during all the steps of the electrification project. Also provides information on the responsibilities involved in the implementation of rural power systems.
IEC 62257-4:2005 Part 4	System selection and design	Provides a method for describing the results to be achieved by the electrification system independently of the technical solutions that could be implemented. Lists the functional requirements that shall be achieved by the production and distribution subsystems.
IEC 62257-5:2005 Part 5	Protection against electrical hazards	Specifies the general requirements for the protection of persons and equipment against electrical hazards to be applied in decentralised rural electrification systems. Requirements dealing with protection against electric shock are based on the rules taken from IEC 61140 and IEC 60364.
IEC 62257-6:2005 Part 6	Acceptance, operation, maintenance and replacement	Describes the various rules to be applied for acceptance, operation, maintenance and replacement of decentralized rural electrification systems which are designed to supply electric power for sites which are not connected to a large interconnected system, or a national grid, in order to meet basic needs.

Annex 3: References and bibliography

- Alfonso Guzman, Castalia Consulting, in Working Group 4: EU PV Technology Platform, “Philippines Off-Grid Generation: PPP in off-grid generation”, 2010.
- Alliance for Rural Electrification, “Green light for renewables in Developing countries”, 2009
- Alliance for Rural Electrification, “Hybrid power systems based on renewable energies: a suitable and cost-competitive solution for rural electrification,” 2008.
- B. Ortiz, M. Vetter, S. Gölz, G. Bopp, Fraunhofer ISE, “Concepts for Hybrid PV Village Grids to Make their Operation a Local Business”, 2007.
- Eric Martinot, Akanksha Chaurey, Debra Lew, Jose Roberto Moreira and Njeri Wamukonya, Rev. Energy Environment, “Renewable energy markets in developing countries”, 2002.
- Eric Martinot and Kilian Reiche, the World Bank, “Regulatory Approaches to Rural Electrification and Renewable Energy: Case Studies from Six Developing Countries”, 2000.
- ESMAP, “Maximizing the Productive Uses of Electricity to Increase the Impact of Rural Electrification Programs”, 2008.
- ESMAP, “Regulatory Review of Power Purchase Agreements: A Proposed Benchmarking Methodology”, 2008.
- ESMAP Technical Paper, “Technical and Economic Assessment of Off-grid, Mini-grid and Grid Electrification Technologies”, 2007.
- ESMAP Technical Paper, “Mini-Grid Design Manual”, 2000.
- ESMAP Technical Paper, “Solar-diesel Hybrid Options for the Peruvian Amazon, Lessons Learned from Padre Cocha”, 2007.
- Gül T. “Integrated analysis of hybrid systems for rural electrification in developing countries”, 2004.
- Hanisch C., Rev. Environment Science Technology, “Establishing renewable energy markets”, 1999.
- IEC, “Recommendations for small renewable energy and hybrid systems for rural electrification Part 4: System selection and design”, 2005.
- IEC, “Recommendations for small renewable energy and hybrid systems for rural electrification - Part 2: From requirements to a range of electrification systems”, 2002.
- Julie M. Bayking, IFC, “Financing Village-Level Energy for Development in Asia-Pacific”, 2008.
- Julie M. Bayking, IFC, “Securing Private Sector Participation in Off-Grid Areas - The Greatest Reward of All”, 2008.
- Khanh Q. Nguyen, Vietnamese Department of Energy Economics, “Alternatives to grid extension for rural electrification: Decentralized renewable energy technologies in Vietnam”, 2006.
- OECD/IEA, “World Energy Outlook 2006”, Paris, 2006.
- OECD/IEA, “World Energy Outlook 2008”, Paris, 2008.

- Paper No.18, World Bank, “Electrification and Regulation: Principles and a Model Law Paper”, 2006.
- Pradeep J. Tharakana, Julio de Castrob, Timm Kroegerc, Energy Policy 35, “Energy sector assistance in developing countries: Current trends and policy recommendations”, 2005.
- REN 21, “RENEWABLE ENERGIES FOR AFRICA: Potential, Markets and Strategies”, 2010.
- Renewable Energy Project Toolkit Case Study, The World Bank, “Sri Lanka Renewable Energy Program”, 2008 and <http://www.energyservices.lk>
- SEPA/UNDP/GEF, “China Village Power Project Development Guidebook: Getting Power to the People Who Need it Most, A practical Guidebook for the development of Renewable Energy Systems for Village Power Projects”, 2005.
- Solano Peralta M., “Tropicalization of feed-in tariffs: A preliminary study on the renewable premium tariff”, 2008.
- Steven Ferry and Anil Cabraal, ESMAP, “Power Purchase Agreements for Small Power Producers”, 2006.
- The South African Institute of International Affairs, “Nepad Policy Focus Series: Working Together Assessing Public-Private Partnerships in Africa”, 2005.
- The World Bank, “Electrification and Regulation: Principles and a Model Law”, 2006.
- The World Bank, “Operational Guidance for World Bank Group Staff: Designing Sustainable Off-Grid Rural Electrification Projects: Principles and Practices”, 2008.
- The World Bank, “REToolkit: A Resource for Renewable Energy Development”, 2008.
- UNDP / ESMAP, “Reducing the Cost of Grid Extension for Rural Electrification”, 2000.
- UNDP / GEF “Financing Mechanisms and Public/Private Risk Sharing Instruments for Financing Small Scale Renewable Energy Equipment and Projects”, 2007.
- UNEP / GEF, “Financing Mechanisms and Public/Private Risk Sharing Instruments for Financing Small Scale Renewable Energy Equipment and Projects”, 2007.
- UNIDO / REEEP, “Session 13: User Financing via Micro Finance Institutions and Utility Bills”, 2008.
- UNIDO / REEEP, “Module 9: Regulatory and policy options to encourage development of renewable energy”, 2008.
- US Department of Energy, “2008 Renewable Energy Data Book,” 2008.
- Vallvé X., TTA, “PV hybrid micro-grid topology based don load management for village water pumping in Senegal”, 2008.
- Xavier Lemaire, REEEP/SERN webinar, www.leonardo-energy.org, “How to Provide Cost-effective and Sustainable Rural Energy Services in Remote Areas of Developing”, 2009.

These members and friends of the Alliance for Rural Electrification have contributed to this paper through the provision of case studies or their support:

- Andy Schroeter, Sunlabob.
- Anjali Shanker, IED.
- Balthasar Klimbie, Fortis Wind Energy.
- Fabian Jochem, Juwi Solar GmbH.
- Lars Koerner, SolarWorld.
- Martin Bölli, Matthias Wiget, Entec AG.
- Matthias Vetter, Brisa Ortiz, Fraunhofer ISE
- Mike Bergey, Charlie Dou, Bergey Wind Power.
- Xavier Vallvé, Trama Tecno Ambiental.

Tables and graphs:

The table 1, 2, 3, 4 and 5 were made by the Alliance as were the graphs 1, 2, 3, 4, 13, 14 and 15. The calculation were made with the software HOMER developed by the US National Renewable Energy Laboratory (NREL).

List of norms and standards referred to in this paper:

- BWEA Small Wind turbine Performance and Safety Standards
- IEC/TS 62257-4 e part 4
- IEC/TS 62257-2 part 2
- IEC 61427
- IEC 61215
- IEC 61730
- IEC 62124
- IEC 62257-2:2004 Part 2
- IEC 62257-3:2004 Part 3
- IEC 62257-4:2005 Part 4
- IEC 62257-5:2005 Part 5
- IEC 62257-6:2005 Part 6

ARE Members

- Agence de Développement de l'Électrification Rurale (ADER)
AI Emadi Solar: www.alemadisolar.com
- Ankur Scientific Energy Technologies Pvt. Ltd.: www.ankurscientific.com
- AORA Solar: www.aorasolar.es
- Atersa: www.atersa.com
- Bergey: www.bergey.com
- Blue Sky Energy Inc.: www.blueskyenergyinc.com
- Bornay Aerogeneradores, S.L.U.: www.bornay.com
- Boundless World: www.boundlessworld.nl
- Chemtrols Solar Pvt.: www.chemtrolssolar.com
- Congo Energie Solaire (CES): www.ces-solaire.com
- Distri-elec: www.distri-elec.com
- DSTC Limited: www.dstc-africa.com
- Eauxwell Nigeria Limited: www.eauxwell.com
- EDP - Energias de Portugal SA: www.fundacaoedp.pt
- Ektop: www.ektopsolar.com
- Enel: www.enelgreenpower.com
- Enersys: www.enersys.com
- Entrade: www.entrade.de
- EPIA: www.epia.org
- Eurobat: www.eurobat.org
- Eventbleu: www.eventbleu.com
- FF Solar Energias Renováveis: www.ffiolar.com
- Fondazione Madre Agnese
- Fortis Wind Energy: www.fortiswindenergy.com
- Foundation Rural Energy Services (FRES): www.fres.nl
- Fraunhofer ISE: www.ise.fraunhofer.de
- Fundación ACCIONA Microenergía: www.acciona.es
- GERES: www.geres.eu
- Global Sustainable Energy Solutions: www.ispglobal.org
- Iberdrola: www.iberdrola.es
- id-eee: www.id-eee.net
- Instituto para la diversificación y el ahorro de la energía (IDAE): www.idae.es
- Innovation Energie Développement (IED): www.ied-sa.fr
- Ikratos Africa SA: www.ikratos-africa.com
- Inherent Energy Ltd: www.inherent-energy.com
- IT Power: www.itpower.co.uk
- KACO New Energy: www.kaco-newenergy.com
- Kafita Multipurpose Co-operative Society Ltd
- KXN Nigeria: www.solarsolve.com
- Lynergies: www.lynergies.com
- MB EcoEnergy Systems: www.mbecoenergysystems.com
- MSS Mola Solar Systems: www.mss-worldwide.com

Mobisol: www.plugintheworld.com
Off-Grid Energy Australia: www.offgridenergy.com.au
Orb Energy: www.orbenergy.com
Phaesun: www.phaesun.com
Phocos: www.phocos.com
Potalia: www.potalia.fr
PHPower: www.phpower.com
Rahimafrooz Renewable Energy Ltd: www.rahimafrooz.com
Reiner Lemoine Institut: www.reiner-lemoine-institut.de
RENAC: www.renac.de
RVE.SOL - Soluções de Energia Rural Lda: www.rvesol.com
Rytron: www.rytron.be
Sader: www.sader-congo.com
Saft: www.saftbatteries.com
Schneider Electric: www.schneider-electric.com
SFC Business Partners
Sheerwind: www.sheerwind.com
Siemens: www.siemens.com
Sistemas Solares de Iluminación (Iluméxico): www.ilumexico.mx
SMA: www.sma.de
Socomec: www.socomec.com
Solar Electric Light Fund (SELF): www.self.org
Solarland (Wuxi) Electric Power Technology Limited: www.solarland.com
Solarmate Engineering: www.solarmateng.com
Studer Innotec: www.studer-innotec.com
SunEdison: www.sunedison.com
Sunlabob Renewable Energy: www.sunlabob.com
Sunna Design: www.sunna-design.fr
Synergie Solaire: www.synergiesolaire.org
Team Energy Foundation Inc. (TEFI): www.teamenergy.ph
Tenesol: www.tenensol.com
The Wind Factory: www.thewindfactory.com
Trama TecnoAmbiental: www.tta.com.es
Trojan Battery: www.trojanbattery.com
Union Espanola Fotovoltaica (UNEF): www.unef.es
University of Southampton: www.soton.ac.uk
University of Ulm: www.hs-ulm.de
Village Power: www.village-power.ch
Wind Energy Solutions B.V.: www.windenergysolutions.nl
Wollny Consulting: www.wollny-consulting.com
World Panel Inc.: www.world-panel.com



**Alliance for
Rural
Electrification**
Shining a Light for Progress

**The Alliance for Rural Electrification (ARE)
is an international business association representing
the decentralised energy sector working towards the integration
of renewables into rural electrification markets
in developing and emerging countries.**

**We enable improved energy access through business development
support for more than 80 members along the whole value chain
for off-grid technologies by targeted advocacy and facilitating access
to international and regional funding.**

**ARE serves as a global platform for sharing knowledge
and best practices to provide for rapid implementation of available
and advanced RE technologies and services.**

Authors: Marcus Wiemann, Simon Rolland, Guido Glania · Originally published in March 2011 · First reprint: May 2014

Alliance for Rural Electrification · Rue d'Arlon 69-71 · 1040 Brussels · Belgium
Tel. +32 2 709 55 42 · E-mail: are@ruralelec.org · www.ruralelec.org